ADVANTEST[®]
ADVANTEST CORPORATION

R3477 Series OPT60

WiBro Analysis Software

User's Guide

MANUAL NUMBER FOE-8440226A00

Applicable Model
R3477

Safety Summary

To ensure thorough understanding of all functions and to ensure efficient use of this instrument, please read the manual carefully before using. Note that Advantest bears absolutely no responsibility for the result of operations caused due to incorrect or inappropriate use of this instrument.

If the equipment is used in a manner not specified by Advantest, the protection provided by the equipment may be impaired.

- **Warning Labels**

Warning labels are applied to Advantest products in locations where specific dangers exist. Pay careful attention to these labels during handling. Do not remove or tear these labels. If you have any questions regarding warning labels, please ask your nearest Advantest dealer. Our address and phone number are listed at the end of this manual.

Symbols of those warning labels are shown below together with their meaning.

DANGER: Indicates an imminently hazardous situation which will result in death or serious personal injury.

WARNING: Indicates a potentially hazardous situation which will result in death or serious personal injury.

CAUTION: Indicates a potentially hazardous situation which will result in personal injury or a damage to property including the product.

- **Basic Precautions**

Please observe the following precautions to prevent fire, burn, electric shock, and personal injury.

- Use a power cable rated for the voltage in question. Be sure however to use a power cable conforming to safety standards of your nation when using a product overseas.
- When inserting the plug into the electrical outlet, first turn the power switch OFF and then insert the plug as far as it will go.
- When removing the plug from the electrical outlet, first turn the power switch OFF and then pull it out by gripping the plug. Do not pull on the power cable itself. Make sure your hands are dry at this time.
- Before turning on the power, be sure to check that the supply voltage matches the voltage requirements of the instrument.
- Connect the power cable to a power outlet that is connected to a protected ground terminal. Grounding will be defeated if you use an extension cord which does not include a protected ground terminal.
- Be sure to use fuses rated for the voltage in question.
- Do not use this instrument with the case open.
- Do not place anything on the product and do not apply excessive pressure to the product. Also, do not place flower pots or other containers containing liquid such as chemicals near this

Safety Summary

product.

- When the product has ventilation outlets, do not stick or drop metal or easily flammable objects into the ventilation outlets.
- When using the product on a cart, fix it with belts to avoid its drop.
- When connecting the product to peripheral equipment, turn the power off.

- **Caution Symbols Used Within this Manual**

Symbols indicating items requiring caution which are used in this manual are shown below together with their meaning.

DANGER: Indicates an item where there is a danger of serious personal injury (death or serious injury).

WARNING: Indicates an item relating to personal safety or health.

CAUTION: Indicates an item relating to possible damage to the product or instrument or relating to a restriction on operation.

- **Safety Marks on the Product**

The following safety marks can be found on Advantest products.



: ATTENTION - Refer to manual.



: Protective ground (earth) terminal.



: DANGER - High voltage.



: CAUTION - Risk of electric shock.

- **Replacing Parts with Limited Life**

The following parts used in the instrument are main parts with limited life.

Replace the parts listed below before their expected lifespan has expired to maintain the performance and function of the instrument.

Note that the estimated lifespan for the parts listed below may be shortened by factors such as the environment where the instrument is stored or used, and how often the instrument is used.

The parts inside are not user-replaceable. For a part replacement, please contact the Advantest sales office for servicing.

Each product may use parts with limited life.

For more information, refer to the section in this document where the parts with limited life are described.

Main Parts with Limited Life

Part name	Life
Unit power supply	5 years
Fan motor	5 years
Electrolytic capacitor	5 years
LCD display	6 years
LCD backlight	2.5 years
Floppy disk drive	5 years
Memory backup battery	5 years

- **Hard Disk Mounted Products**

The operational warnings are listed below.

- Do not move, shock and vibrate the product while the power is turned on. Reading or writing data in the hard disk unit is performed with the memory disk turning at a high speed. It is a very delicate process.
- Store and operate the products under the following environmental conditions.
 - An area with no sudden temperature changes.
 - An area away from shock or vibrations.
 - An area free from moisture, dirt, or dust.
 - An area away from magnets or an instrument which generates a magnetic field.
- Make back-ups of important data. The data stored in the disk may become damaged if the product is mishandled. The hard disc has a limited life span which depends on the operational conditions. Note that there is no guarantee for any loss of data.

- **Precautions when Disposing of this Instrument**

When disposing of harmful substances, be sure dispose of them properly with abiding by the state-provided law.

Harmful substances: (1) PCB (polycarbon biphenyl)
 (2) Mercury
 (3) Ni-Cd (nickel cadmium)
 (4) Other
 Items possessing cyan, organic phosphorous and hexadic chromium and items which may leak cadmium or arsenic (excluding lead in solder).

Example: fluorescent tubes, batteries

Environmental Conditions

This instrument should be only be used in an area which satisfies the following conditions:

- An area free from corrosive gas
- An area away from direct sunlight
- A dust-free area
- An area free from vibrations
- Altitude of up to 2000 m

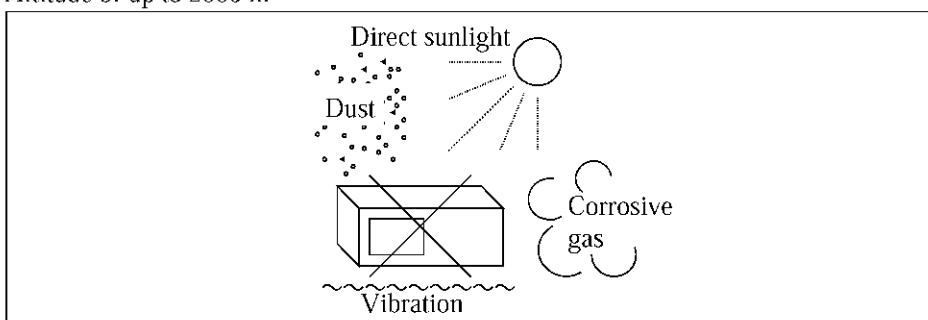

Figure-1 Environmental Conditions

- Operating position

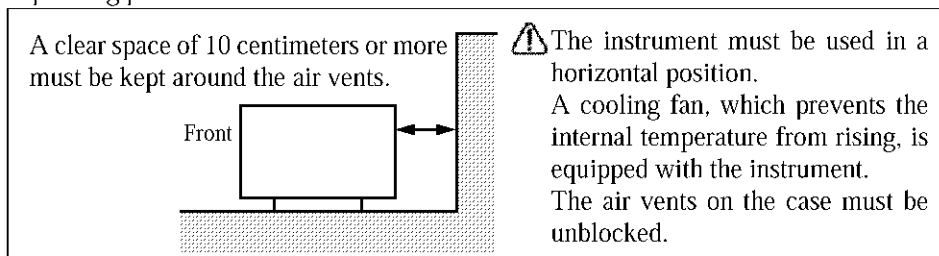

Figure-2 Operating Position

- Storage position

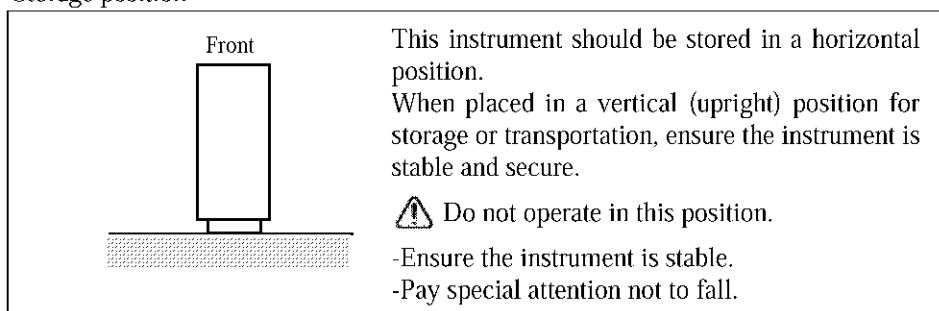

Figure-3 Storage Position

- The classification of the transient over-voltage, which exists typically in the main power supply, and the pollution degree is defined by IEC61010-1 and described below.

Impulse withstand voltage (over-voltage) category II defined by IEC60364-4-443

Pollution Degree 2

Types of Power Cable

Replace any references to the power cable type, according to the following table, with the appropriate power cable type for your country.



Plug configuration	Standards	Rating, color and length	Model number (Option number)
	PSE: Japan Electrical Appliance and Material Safety Law	125 V at 7 A Black 2 m (6 ft)	Straight: A01402 Angled: A01412
	UL: United States of America CSA: Canada	125 V at 7 A Black 2 m (6 ft)	Straight: A01403 (Option 95) Angled: A01413
	CEE: Europe DEMKO: Denmark NEMKO: Norway VDE: Germany KEMA: The Netherlands CEBEC: Belgium OVE: Austria FIMKO: Finland SEMKO: Sweden	250 V at 6 A Gray 2 m (6 ft)	Straight: A01404 (Option 96) Angled: A01414
	SEV: Switzerland	250 V at 6 A Gray 2 m (6 ft)	Straight: A01405 (Option 97) Angled: A01415
	SAA: Australia, New Zealand	250 V at 6 A Gray 2 m (6 ft)	Straight: A01406 (Option 98) Angled: -----
	BS: United Kingdom	250 V at 6 A Black 2 m (6 ft)	Straight: A01407 (Option 99) Angled: A01417
	CCC: China	250 V at 10 A Black 2 m (6 ft)	Straight: A114009 (Option 94) Angled: A114109

TABLE OF CONTENTS

1.	INTRODUCTION	1-1
1.1	Outline of This Manual	1-1
1.2	Product Overview	1-2
1.3	Other Manuals Related to This Instrument	1-2
1.4	Conventions of Notation Used in This Document	1-3
1.5	Trademarks and Registered Trademarks	1-3
2.	PRECAUTIONS WHEN USING THE R3477	2-1
2.1	If a Fault Occurs	2-1
2.2	Removing the Case	2-1
2.3	Power Fuse	2-2
2.4	Built-in Flash Memory	2-3
2.5	Handling the Touch Screen	2-3
2.6	To Avoid Disrupting the Software Environment	2-4
2.7	Note on Transportation	2-5
2.8	Electromagnetic Interference	2-5
2.9	Note when Turning on the Power	2-5
2.10	Restrictions Imposed when Using Windows XP	2-6
3.	SETUP	3-1
3.1	Inspection on Delivery	3-1
3.2	Installation Environment	3-2
3.2.1	Operating Environment	3-2
3.2.2	Protecting Against Electrostatic Discharge	3-3
3.3	Connection of Accessories	3-5
3.3.1	Caution when Connecting Peripherals	3-5
3.4	Power Supply	3-6
3.4.1	Power Requirements	3-6
3.4.2	Connecting the Power Cable	3-6
3.5	Checking Operations	3-8
4.	MEASUREMENT EXAMPLES	4-1
4.1	Modulation Analysis	4-1
4.2	Example of the Measurement that Uses the Equalizer Function	4-6
4.3	Modulation Analysis of a Continuous Wave	4-8
4.4	Ramp Measurement	4-12
5.	MENU MAP, FUNCTIONAL EXPLANATION	5-1
5.1	Menu Index	5-1
5.2	Switching Communication Systems	5-4
5.3	Key Function Descriptions	5-5

Table of Contents

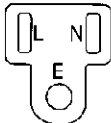
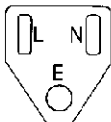
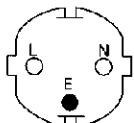
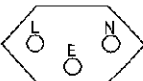
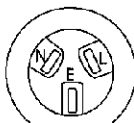
5.3.1	FUNC	5-5
5.3.1.1	CHANNEL POWER	5-10
5.3.1.2	OBW	5-11
5.3.1.3	SPECTRUM EMISSION MASK	5-12
5.3.1.4	SPURIOUS EMISSIONS	5-14
5.3.1.5	ACLR	5-16
5.3.1.6	MULTI CARRIER ACLR	5-17
5.3.1.7	MODULATION (Downlink)	5-20
5.3.1.8	T-Domain Power	5-29
5.3.1.9	ON/OFF Ratio	5-31
5.3.1.10	CCDF	5-32
5.3.2	MKR	5-33
5.3.2.1	MKR (MODULATION - Downlink)	5-33
6.	SCPI COMMAND REFERENCE	6-1
6.1	Command Reference Format	6-1
6.2	Common Commands	6-3
6.3	Modulation Analysis Commands (Downlink)	6-4
6.3.1	Subsystem-INPUT	6-4
6.3.2	Subsystem-CONFigure	6-4
6.3.3	Subsystem-SENSe	6-5
6.3.4	Subsystem-MEASure/READ/FETCh	6-7
6.3.5	Subsystem-INITiate	6-8
6.3.6	Subsystem-TRIGger	6-9
6.3.7	Subsystem-DISPlay	6-9
6.3.8	Subsystem-MMEMory	6-11
6.3.9	Subsystem-SYSTem	6-11
6.4	Other Commands	6-12
6.4.1	Subsystem-INPUT	6-12
6.4.2	Subsystem-SENSe	6-13
6.4.3	Subsystem-CONFigure	6-21
6.4.4	Subsystem-MEASure/READ/FETCh	6-22
6.4.5	Subsystem-INITiate	6-29
6.4.6	Subsystem-TRIGger	6-29
6.4.7	Subsystem-DISPlay	6-30
6.4.8	Subsystem-MMEMory	6-30
6.4.9	Subsystem-CALCulate	6-31
6.4.10	Subsystem-SYSTem	6-34
6.4.11	Subsystem-STATus	6-34
6.5	Status Register	6-35
7.	PERFORMANCE VERIFICATION	7-1
7.1	Test Signal Specifications	7-1
7.2	Test Procedures	7-2
7.3	Test Data Record Sheets	7-3
8.	SPECIFICATIONS	8-1

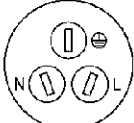
8.1	WiBro 16e Modulation Analysis Performance	8-1
	APPENDIX	A-1
A.1	Technical Data	A-1
A.1.1	Measured Value Calculation Method	A-1
A.1.2	Estimation of the Subcarrier Modulation Format	A-5
A.1.3	Frequency Characteristics Correction Function	A-5
A.1.4	Pilot Synchronization Function	A-8
A.2	Error Message List	A-9
	ALPHABETICAL INDEX	I-1

LIST OF ILLUSTRATIONS

No.	Title	Page
2-1	Fuse Holder Location	2-2
2-2	Fuse Holder	2-2
3-1	Operating Environment	3-2
3-2	Operating Position	3-3
3-3	Storage Position	3-3
3-4	Countermeasures for Static Electricity from the Human Body	3-4
3-5	Countermeasures for Static Electricity from the Work Floor	3-4
3-6	Countermeasures for Static Electricity from the Workbench	3-4
3-7	A Ferrite Core	3-5
3-8	Connecting the Power Cable	3-6
3-9	POWER switch	3-8
3-10	Initial Screen	3-9
3-11	Autocalibration	3-9
4-1	Connection Diagram for the Modulation Analysis	4-1
4-2	[Mod Analysis(1) Setup] Dialog Box	4-2
4-3	[Mod Analysis(2) Setup] Dialog Box	4-3
4-4	[Signal Setup] Dialog Box	4-4
4-5	Modulation Analysis Results	4-4
4-6	Display Example of Constellation Error Time	4-5
4-7	Connection Diagram Using the Equalizing Filter	4-6
4-8	[Mod Analysis(1) Setup] Dialog Box when Using the Equalizer	4-7
4-9	Connection Diagram for Modulation Analysis	4-8
4-10	[Mod Analysis(1) Setup] Dialog Box	4-9
4-11	[Mod Analysis(2) Setup] Dialog Box	4-10
4-12	[Signal Setup] Dialog Box	4-11
4-13	Modulation Analysis Results for a Continuous Wave	4-11
4-14	Connection Diagram for the Ramp Measurement	4-12
4-15	[Ramp] Dialog Box	4-13
4-16	[Signal Setup] Dialog Box	4-13
4-17	Ramp Measurement Results	4-14
6-1	Status Registers	6-35
7-1	Connection Diagram of Signal Source	7-2

LIST OF TABLES

No.	Title	Page
3-1	Standard Accessory	3-1
3-2	ESD Countermeasures	3-3
3-3	Power Requirements	3-6
7-1	List of Test Signal Specifications	7-1
A-1	Frequency Characteristics Correction by using Equalizer	A-7
A-2	Error Message List	A-9

1. INTRODUCTION

This chapter describes the outline of this manual and the product overview of the R3477 series signal analyzer option 60 WiBro Analysis.

1.1 Outline of This Manual

The outline of each chapter is shown below:

For basic operating methods, functions and the remote programming method of the signal analyzer, refer to "1.3 Other Manuals Related to This Instrument."

Chapter 1. INTRODUCTION	Describes the outline of this manual and the product overview.
Chapter 2. PRECAUTIONS WHEN USING THE R3477	Provides preliminary tips on using this instrument. Read this chapter before using this instrument.
Chapter 3. SETUP	Describes how to set up this instrument. After installing this instrument in position, switch it on to make sure that it starts successfully.
Chapter 4. MEASUREMENT EXAMPLES	Describes example measurements.
Chapter 5. MENU MAP, FUNCTIONAL EXPLANATION	Describes the menu configuration and functions of the soft keys.
Chapter 6. SCPI COMMAND REFERENCE	SCPI command reference. The command reference describes the commands in order of function. The following items are described: <ul style="list-style-type: none"> • Command format • Function description • Parameters • Query response
Chapter 7. PERFORMANCE VERIFICATION	Describes the performance verification test procedures for option 60.
Chapter 8. SPECIFICATIONS	Shows the specifications of option 60.
APPENDIX	Describes operation principles and the error code table.

1.2 Product Overview

1.2 Product Overview

The WiBro analysis option (OPT60) is optional software that adds the Tx Tester function, which is used to measure the WiBro base station signal, to the R3477 series.

This option includes the following features.

- The modulation analysis function measures constellation error, center frequency error, and power.
- The Ramp measurement function acquires a burst waveform, synchronizes it with the preamble, and displays it with the template.
- Measurement of Spectrum Mask, which are compliant with the standard, by using simple key sequences.

1.3 Other Manuals Related to This Instrument

The following manuals are available for this instrument:

- User's Guide (Part Code: {ER3477-U}, English)
This manual describes, in addition to how to use the R3477 series Signal Analyzer, the following information: setup, basic operations, applied measurements, function descriptions, controlling by remote, specifications, and maintenance.
- Performance Test Guide (Part Code: {ER3477-T}, English)
This manual describes information, which is required to check the performance of the R3477 series Signal Analyzer, such as performance test procedures and specifications.

1.4 Conventions of Notation Used in This Document

In this document, hard keys, touch-screen buttons and menus are represented by the following symbols:

Hard keys

"Hard keys" are hardware keys which are on the panel.

Sample

Indicates a hard key labeled "Sample."

Example: **FREQ**, **LEVEL**

Touch-screen system menus

[Sample]

Indicates a touch-screen menu, tab, button or dialog box that is labeled "Sample" and that is selected or executed when touched.

Example: **[Normal]** tab, **[Option]** button

Touch-screen soft menu bar

Sample

Indicates a touch-screen soft menu bar labeled "Sample."

Example: **Center** key, **Ref Level** key

Sequential key operation

FREQ

Center

Indicates that you need to touch the **FREQ** key and then touch the **Center** key.

Toggle key operation

ΔMarker On/Off

(On)

Indicates that you need to touch the **ΔMarker On/Off** key to turn on the ΔMarker.

1.5 Trademarks and Registered Trademarks

- Microsoft® and Windows® are trademarks or registered trademarks of Microsoft Corporation in the United States and other countries.
- Other product and company names referenced herein are trademarks or registered trademarks of their respective owners.

2. PRECAUTIONS WHEN USING THE R3477

This chapter describes precautions when using this instrument. Read this chapter before using this instrument.

2.1 If a Fault Occurs

If any smoke, smell, or noise emanates from this instrument, turn off the MAIN POWER switch, remove the power cable from the AC power connector, and then contact an Advantest sales representative immediately.

2.2 Removing the Case

The case of this instrument should only be opened by Advantest service engineers.

WARNING: *This instrument contains high-voltage and high temperature parts which may cause electrical shocks or burns.*

2.3 Power Fuse

2.3 Power Fuse

This instrument is protected from overcurrent by a power fuse. If the power fuse blows, there may be some problems in this instrument. Contact Advantest and request a sales representative to repair this instrument.

The power fuse is placed in a fuse holder which is located on the rear panel.

The power fuse can be checked or replaced according to the following procedure:

WARNING: Use the same rating and same type power fuse to prevent a fire.

1. Press the **POWER** switch on the front panel to turn off the power supply if the instrument operates.
2. Set the MAIN POWER switch to OFF and remove the power cable from the AC power connector.
3. Remove the fuse holder located on the rear panel by using a flathead screwdriver.
4. Check or replace the power fuse and put the fuse holder back in.

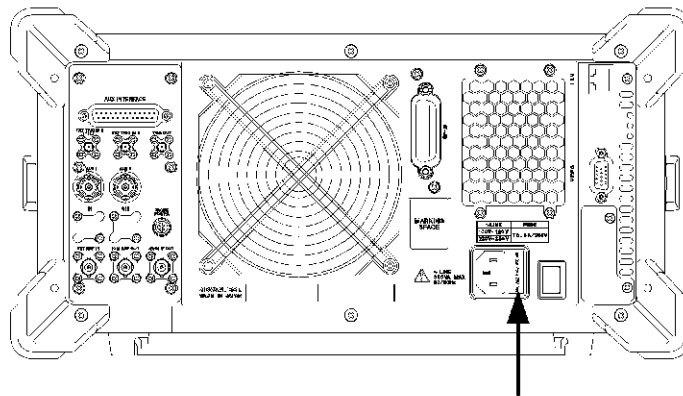

Figure 2-1 Fuse Holder Location

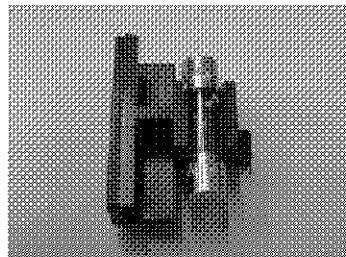

Figure 2-2 Fuse Holder

2.4 Built-in Flash Memory

Because flash memory is included in this instrument, be careful of the following:

- Do not turn off the power when the access lamp lights.
Data which is being accessed may be damaged.

NOTE: *Advantest is not responsible for any consequences if any unusual circumstances cause an abnormality to occur in the built-in flash memory and the stored data is erased or corrupted.*

2.5 Handling the Touch Screen

Because the touch screen is included in this instrument, be careful of the following:

- Avoid giving strong impact or excessive force to the screen.
The glass screen may become damaged.
- Using a hard-pointed material such as a mechanical pencil or a ballpoint may damage the screen.

2.6 To Avoid Disrupting the Software Environment

This instrument includes Microsoft Windows XP Embedded.

Because the functions of this instrument depend on the Windows environment, do not alter the Windows environment in any way other than described in this manual.

This instrument is not a data processor. Only perform the operations which are described in this manual.

1. Non-permitted actions:

- Installing other application programs
- Changing or deleting items in the control panel (except for those procedures described in "A.2 Installing the Printer Driver" and "A.3 Setting up the Network" in the R3477 Series User's Guide)
- Opening or changing existing files in C drive
- Starting or operating other application programs during measurement
- Upgrading the Windows operating system
- If this instrument operates incorrectly after an application is installed, the Windows operating system must be reinstalled. Contact Advantest and request a sales representative to reinstall the system.

2. Computer viruses

Depending on how the operating environment is used, the system may become infected by a computer virus.

To prevent any infections, we recommend the following counter measures:

- Checking for viruses before loading a file or inserting any media from an outside source.
- Make sure that all networks have been checked for viruses before connecting.

Steps to take if this instrument becomes infected by a computer virus

- We recommend that the system be reinstalled. Contact Advantest and request a sales representative to reinstall the system.

2.7 Note on Transportation

When carrying this instrument, be careful of the following:

- If using this instrument on a cart, secure both this instrument and the cart with a belt.

2.8 Electromagnetic Interference

This instrument may cause electromagnetic interference and affect television and radio. If this instrument's power is turned off and any electromagnetic interference that may be present is reduced, then this instrument has caused the interference.

Electromagnetic interference from this instrument may be prevented by the following precautions.

- Changing the direction of the antenna of the television or radio.
- Placing this instrument on the other side of the television or radio.
- Placing this instrument away from the television or radio.
- Using a different power source for the television or radio, and this instrument.

2.9 Note when Turning on the Power

When turning on the power, do not connect a DUT to this instrument.

2.10 Restrictions Imposed when Using Windows XP

2.10 Restrictions Imposed when Using Windows XP

END-USER LICENSE AGREEMENT

- You have acquired a device ("INSTRUMENT") that includes software licensed by [ADVANTEST] from Microsoft Licensing Inc. or its affiliates ("MS"). Those installed software products of MS origin, as well as associated media, printed materials, and "online" or electronic documentation ("SOFTWARE") are protected by international intellectual property laws and treaties. The SOFTWARE is licensed, not sold. All rights reserved.
- IF YOU DO NOT AGREE TO THIS END USER LICENSE AGREEMENT ("EULA"), DO NOT USE THE INSTRUMENT OR COPY THE SOFTWARE. INSTEAD, PROMPTLY CONTACT [ADVANTEST] FOR INSTRUCTIONS ON RETURN OF THE UNUSED INSTRUMENT(S) FOR A REFUND. ANY USE OF THE SOFTWARE, INCLUDING BUT NOT LIMITED TO USE ON THE INSTRUMENT, WILL CONSTITUTE YOUR AGREEMENT TO THIS EULA (OR RATIFICATION OF ANY PREVIOUS CONSENT).
- **GRANT OF SOFTWARE LICENSE.** This EULA grants you the following license:
 - You may use the SOFTWARE only on the INSTRUMENT.
 - **NOT FAULT TOLERANT. THE SOFTWARE IS NOT FAULT TOLERANT.** [ADVANTEST] HAS INDEPENDENTLY DETERMINED HOW TO USE THE SOFTWARE IN THE INSTRUMENT, AND MS HAS RELIED UPON [ADVANTEST] TO CONDUCT SUFFICIENT TESTING TO DETERMINE THAT THE SOFTWARE IS SUITABLE FOR SUCH USE.
 - **NO WARRANTIES FOR THE SOFTWARE. THE SOFTWARE is provided "AS IS" and with all faults. THE ENTIRE RISK AS TO SATISFACTORY QUALITY, PERFORMANCE, ACCURACY, AND EFFORT (INCLUDING LACK OF NEGLIGENCE) IS WITH YOU. ALSO, THERE IS NO WARRANTY AGAINST INTERFERENCE WITH YOUR ENJOYMENT OF THE SOFTWARE OR AGAINST INFRINGEMENT. IF YOU HAVE RECEIVED ANY WARRANTIES REGARDING THE INSTRUMENT OR THE SOFTWARE, THOSE WARRANTIES DO NOT ORIGINATE FROM, AND ARE NOT BINDING ON, MS.**
 - **No Liability for Certain Damages. EXCEPT AS PROHIBITED BY LAW, MS SHALL HAVE NO LIABILITY FOR ANY INDIRECT, SPECIAL, CONSEQUENTIAL OR INCIDENTAL DAMAGES ARISING FROM OR IN CONNECTION WITH THE USE OR PERFORMANCE OF THE SOFTWARE. THIS LIMITATION SHALL APPLY EVEN IF ANY REMEDY FAILS OF ITS ESSENTIAL PURPOSE. IN NO EVENT SHALL MS BE LIABLE FOR ANY AMOUNT IN EXCESS OF U.S. TWO HUNDRED FIFTY DOLLARS (U.S.\$250.00).**
 - **Limitations on Reverse Engineering, Decompilation, and Disassembly.** You may not reverse engineer, decompile, or disassemble the SOFTWARE, except and only to the extent that such activity is expressly permitted by applicable law notwithstanding this limitation.
 - **SOFTWARE TRANSFER ALLOWED BUT WITH RESTRICTIONS.** You may permanently transfer rights under this EULA only as part of a permanent sale or transfer of the INSTRUMENT, and only if the recipient agrees to this EULA. If the SOFTWARE is an upgrade, any transfer must also include all prior versions of the SOFTWARE.
 - **EXPORT RESTRICTIONS.** You acknowledge that SOFTWARE is of US-origin. You agree to comply with all applicable international and national laws that apply to the SOFTWARE, including the U.S. Export Administration Regulations, as well as end-user, end-use and country destination restrictions issued by U.S. and other governments. For additional information on exporting the SOFTWARE, see <http://www.microsoft.com/exporting/>.
- ⌈ **Installation and Use.** The SOFTWARE may not be used by more than two (2) processors at any one time on the INSTRUMENT. You may permit a maximum of ten (10) computers or other electronic devices (each a "Client") to connect to the INSTRUMENT to utilize the services of the SOFTWARE solely for file and print services, internet information services, and remote access (including connection sharing and telephony services). The ten (10) connection maximum includes any indirect connections made through "multiplexing" or other software or hardware which pools or aggregates connections. Except as otherwise permitted in the NetMeeting/Remote Assistance/Remote Desktop Features terms below, you may not use a Client to use, access, display or run the SOFTWARE, the SOFTWARE's user interface or other executable software residing on the INSTRUMENT.
- ⌈ If you use the INSTRUMENT to access or utilize the services or functionality of Microsoft Windows Server products (such as Microsoft Windows NT Server 4.0 (all editions) or Microsoft Windows 2000 Server (all editions)), or use the INSTRUMENT to permit workstation or computing devices to access or utilize the services or functionality of Microsoft Windows Server products, you may be required to obtain a Client Access License for the INSTRUMENT and/or each such workstation or computing device. Please refer to the end user license agreement for your Microsoft Windows Server product for additional information.
- ⌈ **Restricted Uses.** The SOFTWARE is not designed or intended for use or resale in hazardous environments requiring fail-safe performance, such as in the operation of nuclear facilities, aircraft navigation or communication systems, air traffic control, or other devices or systems in which a malfunction of the SOFTWARE would result in foreseeable risk of injury or death to the operator of the device or system, or to others.
- ⌈ **Restricted Functionality.** You are licensed to use the SOFTWARE to provide only the limited functionality (specific tasks or processes) for which the INSTRUMENT has been designed and marketed by

[ADVANTEST]. This license specifically prohibits any other use of the software programs or functions, or inclusion of additional software programs or functions, on the INSTRUMENT.

Security Updates. Content providers are using the digital rights management technology ("Microsoft DRM") contained in this SOFTWARE to protect the integrity of their content ("Secure Content") so that their intellectual property, including copyright, in such content is not misappropriated. Owners of such Secure Content ("Secure Content Owners") may, from time to time, request MS, Microsoft Corporation or their subsidiaries to provide security related updates to the Microsoft DRM components of the SOFTWARE ("Security Updates") that may affect your ability to copy, display and/or play Secure Content through Microsoft software or third party applications that utilize Microsoft DRM. You therefore agree that, if you elect to download a license from the Internet which enables your use of Secure Content, MS, Microsoft Corporation or their subsidiaries may, in conjunction with such license, also download onto your INSTRUMENT such Security Updates that a Secure Content Owner has requested that MS, Microsoft Corporation or their subsidiaries distribute. MS, Microsoft Corporation or their subsidiaries will not retrieve any personally identifiable information, or any other information, from your INSTRUMENT by downloading such Security Updates.

NetMeeting/Remote Assistance/Remote Desktop Features. The SOFTWARE may contain NetMeeting, Remote Assistance, and Remote Desktop technologies that enable the SOFTWARE or other applications installed on the INSTRUMENT to be used remotely between two or more computing devices, even if the SOFTWARE or application is installed on only one INSTRUMENT. You may use NetMeeting, Remote Assistance, and Remote Desktop with all Microsoft products; provided however, use of these technologies with certain Microsoft products may require an additional license. For both Microsoft products and non-Microsoft products, you should consult the license agreement accompanying the applicable product or contact the applicable licensor to determine whether use of NetMeeting, Remote Assistance, or Remote Desktop is permitted without an additional license.

Consent to Use of Data. You agree that MS, Microsoft Corporation and their affiliates may collect and use technical information gathered in any manner as part of product support services related to the SOFTWARE. MS, Microsoft Corporation and their affiliates may use this information solely to improve their products or to provide customized services or technologies to you. MS, Microsoft Corporation and their affiliates may disclose this information to others, but not in a form that personally identifies you.

Internet Gaming/Update Features. If the SOFTWARE provides, and you choose to utilize, the Internet gaming or update features within the SOFTWARE, it is necessary to use certain computer system, hardware, and software information to implement the features. By using these features, you explicitly authorize MS, Microsoft Corporation and/or their designated agent to use this information solely to improve their products or to provide customized services or technologies to you. MS or Microsoft Corporation may disclose this information to others, but not in a form that personally identifies you.

Internet-Based Services Components. The SOFTWARE may contain components that enable and facilitate the use of certain Internet-based services. You acknowledge and agree that MS, Microsoft Corporation or their affiliates may automatically check the version of the SOFTWARE and/or its components that you are utilizing and may provide upgrades or supplements to the SOFTWARE that may be automatically downloaded to your INSTRUMENT.

Links to Third Party Sites. The SOFTWARE may provide you with the ability to link to third party sites through the use of the SOFTWARE. The third party sites are not under the control of MS, Microsoft Corporation or their affiliates. Neither MS nor Microsoft Corporation nor their affiliates are responsible for (i) the contents of any third party sites, any links contained in third party sites, or any changes or updates to third party sites, or (ii) webcasting or any other form of transmission received from any third party sites. If the SOFTWARE provides links to third party sites, those links are provided to you only as a convenience, and the inclusion of any link does not imply an endorsement of the third party site by MS, Microsoft Corporation or their affiliates.

Additional Software/Services. The SOFTWARE may permit [ADVANTEST], MS, Microsoft Corporation or their affiliates to provide or make available to you SOFTWARE updates, supplements, add-on components, or Internet-based services components of the SOFTWARE after the date you obtain your initial copy of the SOFTWARE ("Supplemental Components").

If [ADVANTEST] provides or makes available to you Supplemental Components and no other EULA terms are provided along with the Supplemental Components, then the terms of this EULA shall apply.

If MS, Microsoft Corporation or their affiliates make available Supplemental Components, and no other EULA terms are provided, then the terms of this EULA shall apply, except that the MS, Microsoft Corporation or affiliate entity providing the Supplemental Component(s) shall be the licensor of the Supplemental Component(s).

[ADVANTEST], MS, Microsoft Corporation and their affiliates reserve the right to discontinue any Internet-based services provided to you or made available to you through the use of the SOFTWARE.

This EULA does not grant you any rights to use the Windows Media Format Software Development Kit ("WMFSDK") components contained in the SOFTWARE to develop a software application that uses Windows Media technology. If you wish to use the WMFSDK to develop such an application, visit <http://msdn.microsoft.com/workshop/imedia/windowsmedia/sdk/wmsdk.asp>, accept a separate license for the WMFSDK, download the appropriate WMFSDK, and install it on your system.

3. SETUP

This chapter describes how to set up this instrument on delivery. Topics covered in this chapter are:

- 3.1 Inspection on Delivery
- 3.2 Installation Environment
- 3.3 Connection of Accessories
- 3.4 Power Supply
- 3.5 Checking Operations

3.1 Inspection on Delivery

After receiving the product, inspect the outside and the accessories according to the following procedure.

1. Check that the shipping container and the cushioning material are not damaged.

IMPORTANT: *If the shipping container or the cushioning material is damaged, keep them until the following inspections are complete.*

2. Check that the outside of the product is not damaged.

WARNING: *If any outside components of the product such as the cover, panel (front or rear), LCD display, power switch, or connector are damaged, do not turn on the power. You may receive an electrical shock.*

3. Check that the standard accessory listed of the OPT60 in Table 3-1 is complete and this is not damaged. If any of the following occur, contact an Advantest sales representative.
 - The shipping container or the cushioning material is damaged, or signs of stress are found.
 - The outside of the product is damaged.
 - The standard accessories are incomplete or are damaged.
 - Defects are found in the operation check.

Table 3-1 Standard Accessory

Name	Model	Quantity	Remarks
R3477 Series OPT60 User's Guide	ER3477OPT60-U	1	English version

3.2 Installation Environment

3.2 Installation Environment

This section describes the environment into which this instrument should be installed.

3.2.1 Operating Environment

Install this instrument in an environment in which the following conditions are satisfied.

- Ambient temperature: 0 °C to +50 °C (operating temperature)
-20 °C to +60 °C (storage temperature)
- Relative humidity: 80 percent or less with no condensation
- An area free from corrosive gas
- An area away from direct sunlight
- A dust-free area
- An area free from vibrations
- A low noise area

Although this instrument has been designed to withstand a certain amount of noise from the AC power line, it should be used in a low noise area. Use a noise cut filter if ambient noise is unavoidable.

- An area in which the airflow is not obstructed.
There is an exhaust-cooling fan on the rear panel and exhaust vents on both sides of this instrument. Do not block the fan and these vents. If there is insufficient exhaust, the internal temperature will rise and the instrument may operate incorrectly. Keep a space of 10 centimeters between the rear panel and the wall. Do not use this instrument on its side.

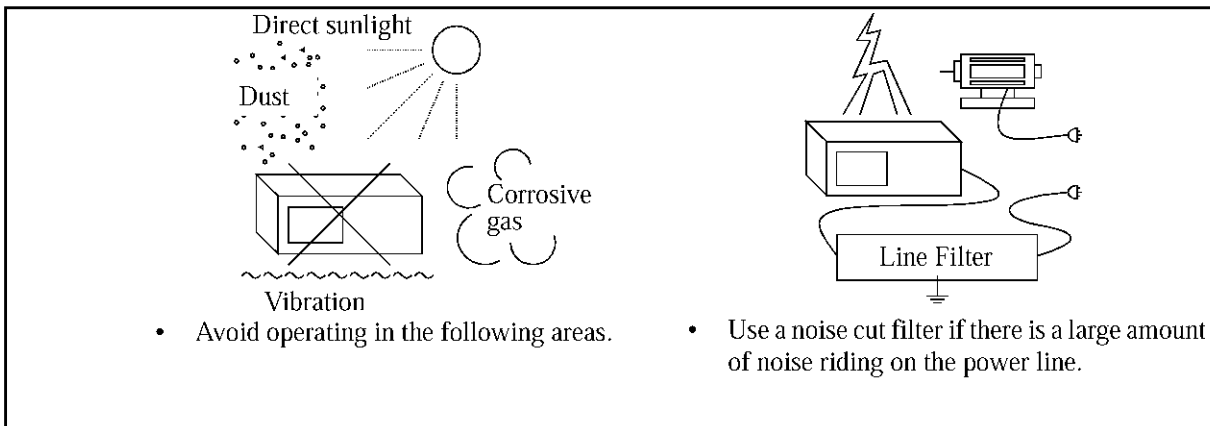

Figure 3-1 Operating Environment

- Operating position

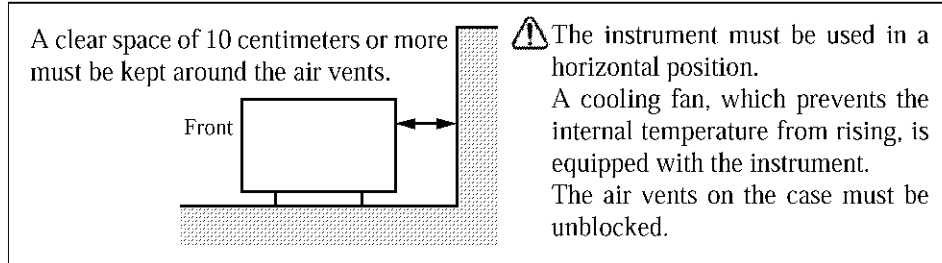

Figure 3-2 Operating Position

- Storage position

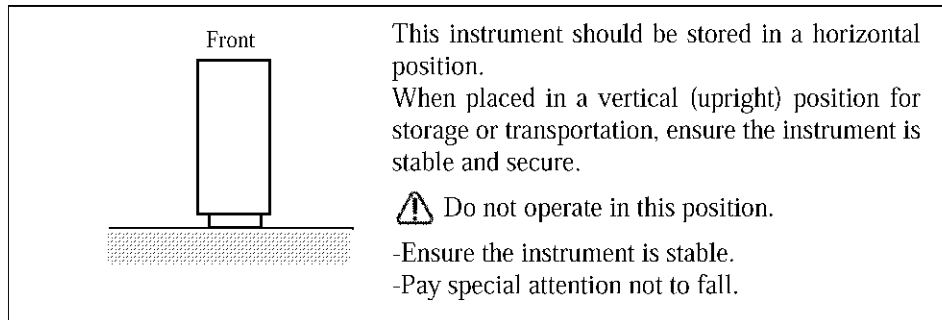

Figure 3-3 Storage Position

3.2.2 Protecting Against Electrostatic Discharge

To prevent semiconductors from being damaged by electrostatic discharge (ESD), the precautions shown below should be taken. We recommend combining two or more countermeasures to prevent damage from ESD.

(Static electricity can be generated easily by the movement of a person or the friction against insulation.)

Table 3-2 ESD Countermeasures

Human Body	Use a wrist strap (See Figure 3-4).
Work floor	Install a conductive mat, use conductive shoes, and connect to earth (See Figure 3-5).
Workbench	Install a conductive mat and connect to earth (See Figure 3-6).

3.2.2 Protecting Against Electrostatic Discharge

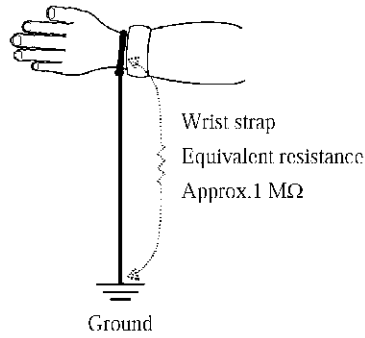

Figure 3-4 Countermeasures for Static Electricity from the Human Body

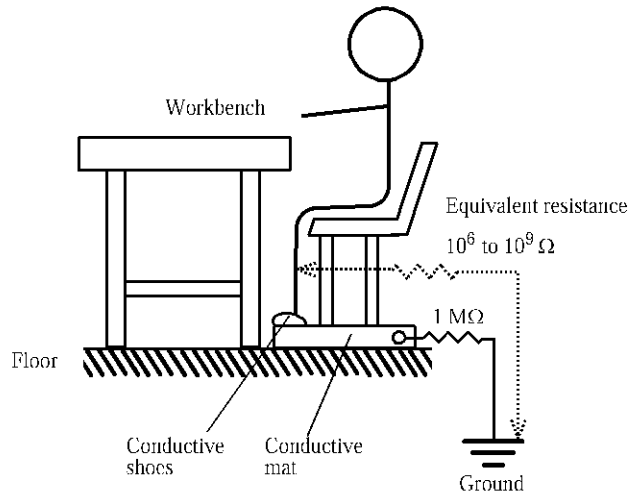

Figure 3-5 Countermeasures for Static Electricity from the Work Floor

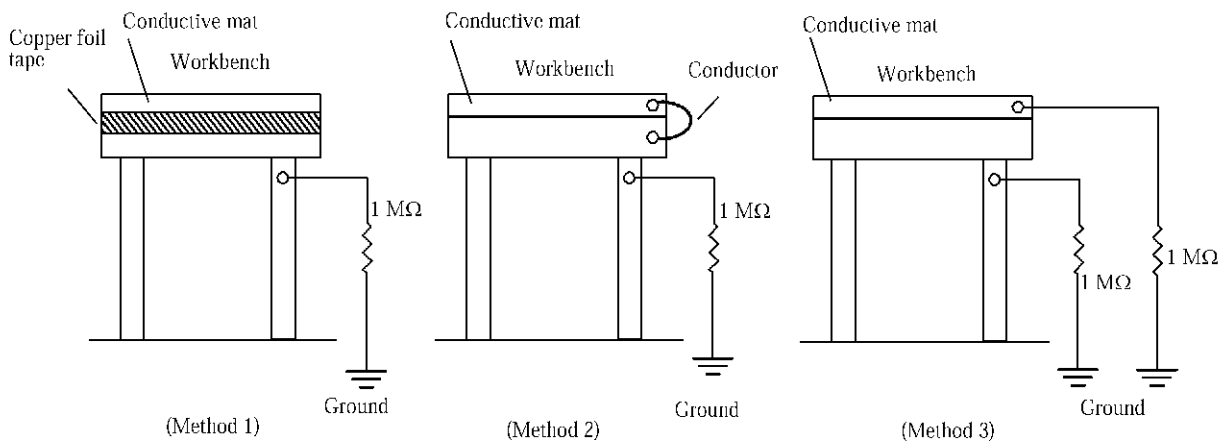

Figure 3-6 Countermeasures for Static Electricity from the Workbench

3.3 Connection of Accessories

This section describes how to connect the accessories required to operate this unit.

3.3.1 Caution when Connecting Peripherals

Use shielded cables when connecting peripherals.

Attach the included ferrite core (MSFC8KEX produced by Okaya Electric Industries Co., Ltd.) to the probe power cable as shown in Figure 3-7.

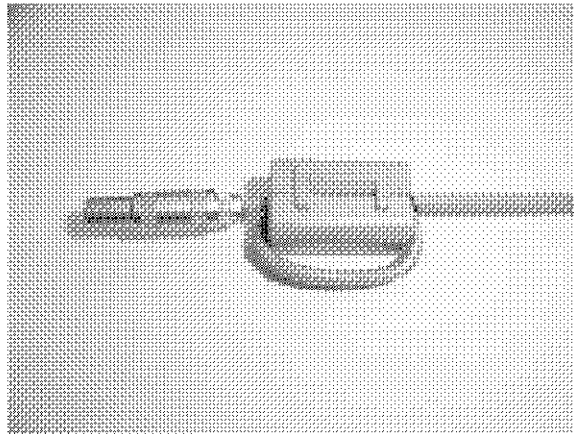

Figure 3-7 A Ferrite Core

3.4 Power Supply

3.4 Power Supply

This section describes power requirements and how to connect the power cable.

3.4.1 Power Requirements

The power requirements of this instrument are shown in Table 3-3. Check that the power supply, which satisfies the conditions shown in Table 3-3, is supplied to this instrument.

Table 3-3 Power Requirements

	100 V AC	200 V AC	Remarks
Input voltage range	90 V-132 V	198 V-250 V	Automatically switches the input voltage between 100 V AC and 200 V AC.
Frequency range	47 Hz-63 Hz		
Power consumption	360 VA or less		

WARNING: Make sure the power supply, which satisfies the power requirements, is supplied to this instrument. If the power requirements are not satisfied, this instrument may be damaged.

3.4.2 Connecting the Power Cable

This instrument includes a three-core power cable with a grounding conductor. To prevent accidents caused by electric shocks, use the included power cable and securely connect to the ground through a three-pin power outlet.

1. Check that the included power cable is not damaged.

WARNING: Never use a damaged power cable. You may receive an electrical shock.

2. Connect the AC power connector on the rear panel of this instrument to a three-pin power outlet that has a protected ground terminal by using the included power cable (see Figure 3-8).

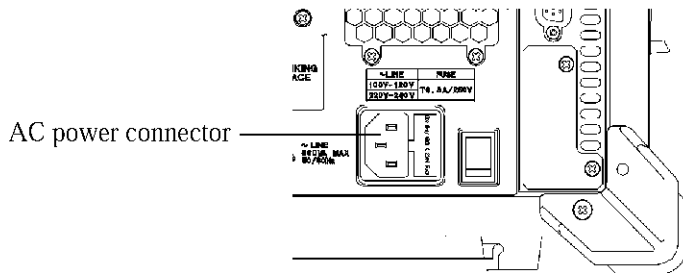

Figure 3-8 Connecting the Power Cable

WARNING:

1. *Use a power cable that is suitable for the power supply voltage. Use a power cable that complies with safety standards of your country (Refer to "Safety Summary").*
 2. *To prevent any danger of electrical shock, connect the power cable to a three-pin power outlet that is connected to a protected ground terminal. The instrument will not be grounded if an extension cord, which does not include a protected ground terminal, is used.*
-

3.5 Checking Operations

3.5 Checking Operations

This section describes how to check operations by using the auto-calibration function of this instrument. Check that this instrument operates correctly by following the procedure below.

Starting this instrument

1. Connect the power cable according to "3.4.2 Connecting the Power Cable."
2. Turn on the MAIN POWER switch on the rear panel.
After turning on the MAIN POWER switch, wait for three seconds or more.
3. Press the **POWER** switch to turn on the instrument.

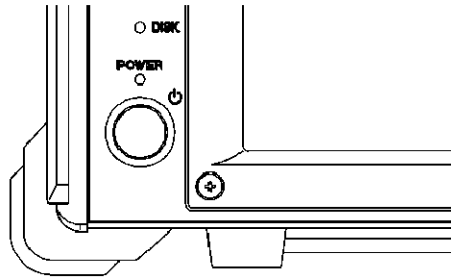

Figure 3-9 POWER switch

NOTE:

1. *If the power supply of this instrument is abruptly disconnected, such as by pulling the power cable out of position, while the instrument is operating, Scandisk launches the next time this instrument starts because the internal flash memory may become damaged.*
2. **Scandisk**
If the power of this instrument is turned off without being shut down, Scandisk launches automatically. Do not abort Scandisk while it is running. If Scandisk detects any faulty clusters, follow the displayed messages and take the appropriate action. The software in this instrument starts automatically after Scandisk is complete.

4. The power-on diagnostic program starts the self-diagnostic.
The self-diagnostic takes approximately one minute to complete.
5. The initial screen shown in Figure 3-10 is displayed if no faults are detected in this instrument during the self-diagnostic.
The initial screen display may differ from Figure 3-10 depending on the status of the settings when the power supply was last turned off.

MEMO: *If any error message is displayed as a result of the self-diagnostic, refer to Chapter 9, "MAINTENANCE" of the R3477 Series User's Guide.*

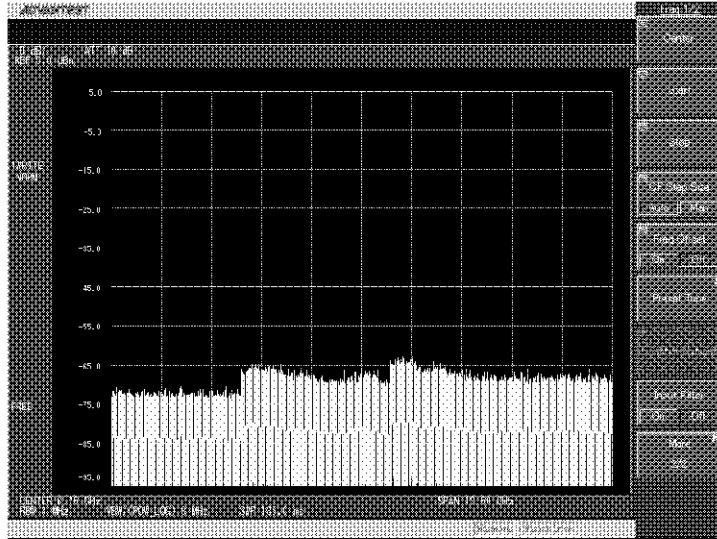

Figure 3-10 Initial Screen

Performing autocalibration

6. Connect as shown in Figure 3-11 by using included N(m)-BNC(f) adapter and input cable (A01037-0300).

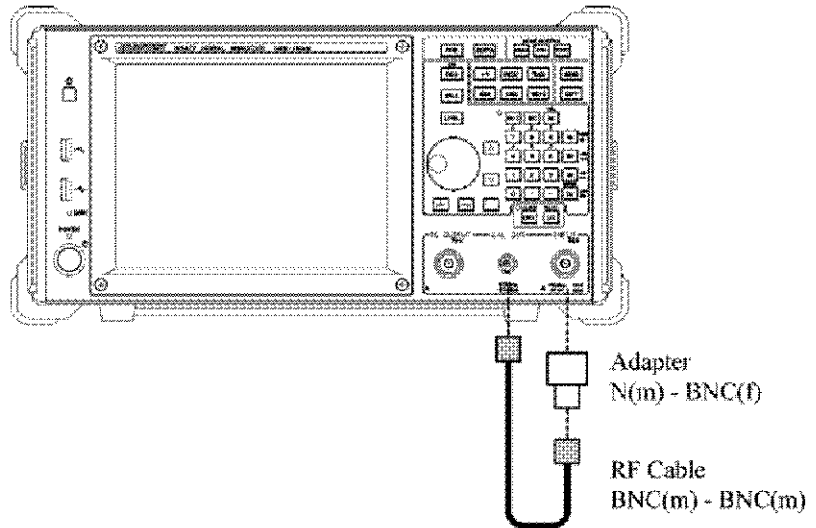

Figure 3-11 Autocalibration

IMPORTANT: Perform autocalibration after allowing a warm up time of at least 30 minutes. For more information on how to perform autocalibration, refer to section 4.3.1, "Autocalibration" of the R3477 Series User's Guide.

3.5 Checking Operations

7. Press the **MENU** key, select the **Cal** key from the soft menu, and select the **SA Cal** key from the soft menu.
8. Autocalibration starts.
It takes approximately one minute to complete the autocalibration.
9. Check that no error message is displayed as a result of the autocalibration.

MEMO: *If any error message is displayed as a result of the autocalibration, refer to Chapter 9, "MAINTENANCE" of the R3477 Series User's Guide.*

Turning off the power supply

10. Press the **POWER** switch.
The system shuts down and the power of the instrument turns off automatically.

4. MEASUREMENT EXAMPLES

This chapter describes how to use this option by using specific measurement examples.

4.1 Modulation Analysis

This section describes the procedure when a burst signal that is compliant with the WiBro standard is measured. Multiple OFDM symbols and frames can be measured repeatedly.



Figure 4-1 Connection Diagram for the Modulation Analysis

Setting measurement conditions

1. Press the **CONFIG** key and touch the **STD Setup** key. The **[STD Setup]** dialog box is displayed on the screen.
2. Set **[Type]** in the **[STD Setup]** dialog box to **[WiBro16e_DL]**.
3. Touch the **Apply** key to apply the new setting.
4. Touch the **Tx Tester** key to select Tx Tester.
5. Press **FREQ**, **Center**, **2**, **3**, **5**, **0**, and **MHz**. The center frequency is now set to 2350 MHz.
6. Press the **FUNC** key and touch the **Modulation** key.
7. Touch **Trigger**, **Trigger Source**, and **Free Run**. The measurement mode is set to internal trigger.
8. Touch the **Return** key twice to return to the Modulation menu.
9. Touch **Meas Mode** and **Modulation Analysis**.
10. Touch the **Return** key to return to the Modulation menu.
11. Touch the **Auto Level Set** key. Ref Level is automatically set to the optimum value.

4.1 Modulation Analysis

12. Touch **Meas Control**, **Meas Parameters**, and **Mod Analysis(1)**.
The **[Mod Analysis(1) Setup]** dialog box is displayed on the screen. Set the measurement parameters in the **[Mod Analysis(1) Setup]** dialog box.
13. To measure the burst signal, set **[Continuous Signal]** to **[OFF]**.
14. To automatically set the threshold level used to search for the burst, set **[Threshold Setup]** to **[Auto]**.
15. To automatically set the measurement window settings, set **[Meas Window Setup]** to **[Auto]**.
16. Set the FFT position for demodulation.
To start the Fourier transform from the center of the guard interval, select **[Symbol Timing]** and press **[0]** and **[Hz]** (ENTER) on the keypad.
17. Select the correction type used when correcting the frequency characteristics and performing the measurement.
To select the preamble correction type, set **[Correction Type]** to **[CH Est(Preamble)]**.
18. Set whether to correct the amplitude for each OFDM symbol by using the pilot subcarrier.
To correct the amplitude by using the pilot subcarrier, set **[Pilot Track(Amplitude)]** to **[ON]**.
19. Set whether to correct the phase for each OFDM symbol by using the pilot subcarrier.
To correct the phase by using the pilot subcarrier, set **[Pilot Track(Phase)]** to **[ON]**.
20. Set **[τ Offset Setup]** to **[OFF]** because the offset cannot be added to the τ measurement result.

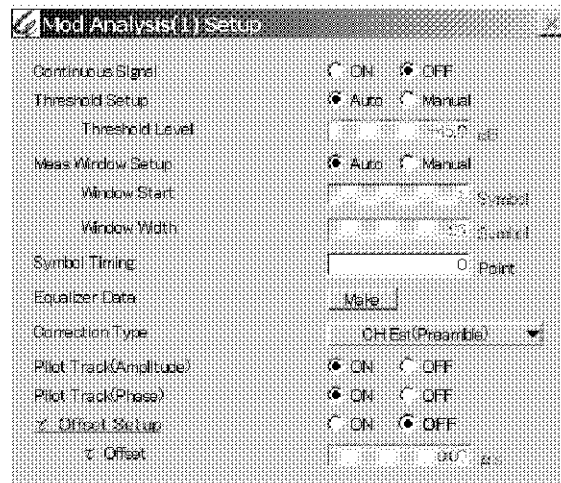

Figure 4-2 **[Mod Analysis(1) Setup]** Dialog Box

21. Touch the **Close** key to close the dialog box.
22. Touch the **Mod Analysis(2)** key.
The **[Mod Analysis(2) Setup]** dialog box is displayed on the screen. Set the measurement conditions in the **[Mod Analysis(2) Setup]** dialog box.

23. To repeat measurements for each frame, set **[Meas Condition]** to **[Frame]**.
24. Set the number of frames to be calculated at any one time to 1. Select **[Meas Frame Length]** and press **[1]** and **[Hz]** (ENTER) on the keypad.
25. Constellation Error Trigger is not used.
Set **[Constellation Error Trigger]** to **[OFF]**.
26. Select a receiving filter.
Set **[Baseband Filter]** to **[Wide]**.

MEMO: Select a filter, whose bandwidth is wider enough than the signal bandwidth, assuming that no signal exists in adjacent channels.

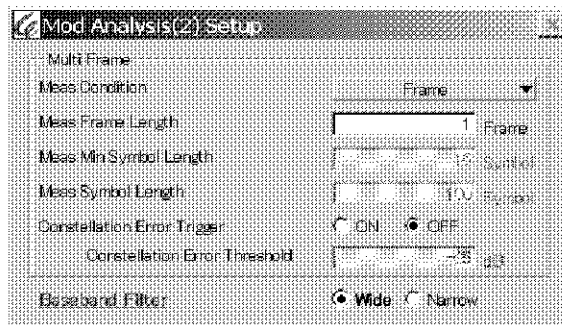

Figure 4-3 **[Mod Analysis(2) Setup]** Dialog Box

27. Touch the **Close** key to close the dialog box.
28. Touch the **Signal** key.
The **[Signal Setup]** dialog box is displayed on the screen. Set the parameters of the signal to be measured in the **[Signal Setup]** dialog box.
29. Enter the signal cell ID.
Select **[Cell ID]** and press **[0]** and **[Hz]** (ENTER) on the keypad.
30. Enter the signal segment number.
Select **[Segment Number]** and press **[0]** and **[Hz]** (ENTER) on the keypad.
31. Set the subchannel type included in the signal.
Set **[Subchannel Type]** to **[PUSC+FUSC]**.
32. Set the number of PUSC subchannel symbols included in the signal.
Select **[Number of PUSC Symbol]** and press **[1]**, **[2]**, and **[Hz]** (ENTER) on the keypad.
33. Set "Permutation Base" of the signal.
Select **[DL PermBase]** and press **[0]** and **[Hz]** (ENTER) on the keypad.
34. Set "PRBS ID" of the signal.
Select **[PRBS_ID]** and press **[0]** and **[Hz]** (ENTER) on the keypad.

4.1 Modulation Analysis

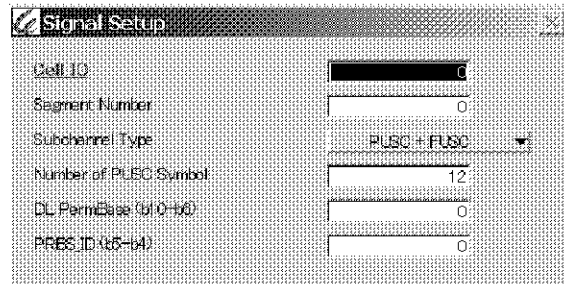

Figure 4-4 [Signal Setup] Dialog Box

35. Touch the **Close** key to close the dialog box.
36. Touch the **Return** key to return to the Meas Control menu.
37. Press the **SINGLE** key on the front panel or touch the **Single Meas** key on the soft menu bar. A Single measurement is performed and the measurement results are displayed on the screen.

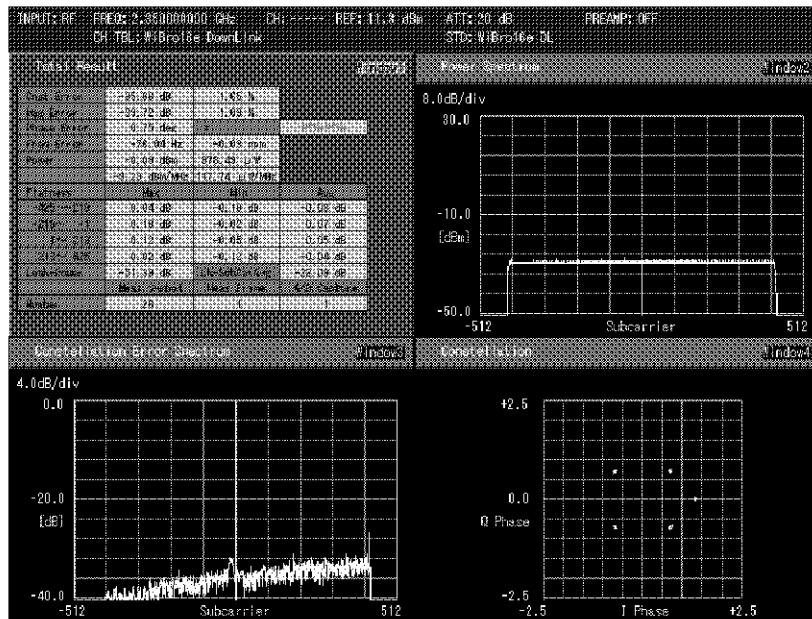

Figure 4-5 Modulation Analysis Results

38. Touch the **Return** key to return to the Modulation menu.
39. To change the graphic display, touch the window to be changed (Window2 in this example).
40. Then, touch **Display**, **Window Format**, and **Format**. The **[Format]** dialog box is displayed on the screen. Select a graph to be displayed in the **[Format]** dialog box.
41. In this example, to display the change with time of the constellation error, select

[Constellation Error Time].

42. Touch the **Close** key to close the dialog box.
43. Touch the **Time Trace** key.
The **[Time Trace]** dialog box is displayed. Set data to be displayed in the **[Time Trace]** dialog box.
44. This example displays average values for each symbol and data for subcarrier number 10. Select **[RMS]** and **[Specified Subcarrier]**. Select the **[Specified Subcarrier]** entry box, press **[1]**, **[0]**, and **[Hz]** (ENTER) on the keypad, then touch **[Apply]**.
45. Touch the **Close** key to close the dialog box.
46. Touch the **Return** key twice to return to the Modulation menu.
47. To adjust the scale of the graph, touch the **Scale** key.
48. Touch the **Y Scale Upper** key and enter the upper limit of the Y scale by using the keypad.
49. Touch the **Y Scale Lower** key and enter the lower limit of the Y scale by using the keypad.

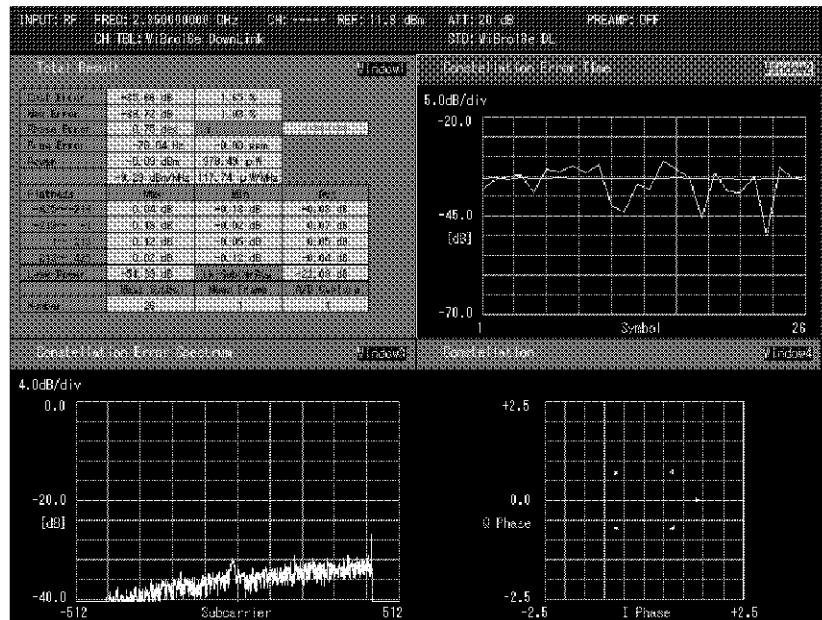

Figure 4-6 Display Example of Constellation Error Time

4.2 Example of the Measurement that Uses the Equalizer Function

4.2 Example of the Measurement that Uses the Equalizer Function

The degradation of a signal, which is caused by a DUT, can be measured by using a function which corrects frequency characteristics of the signal source.

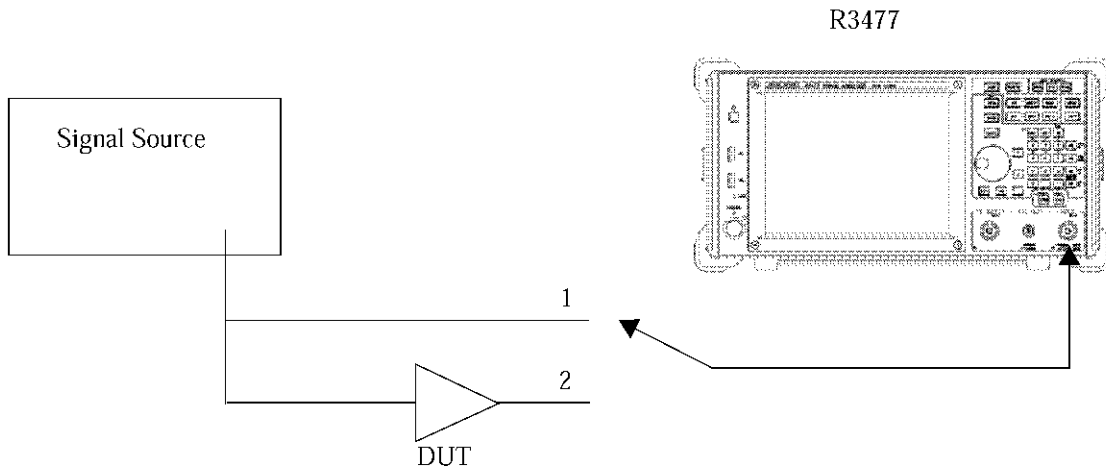

Figure 4-7 Connection Diagram Using the Equalizing Filter

Measurement condition setting

1. Set the signal path shown in Figure 4-7 to 1 and perform the measurement according to the procedure described in Section 4.1. If the Modulation menu is not displayed after the measurement, touch the **Return** key to return to the Modulation menu.
2. Touch **Meas Control**, **Meas Parameters**, and **Mod Analysis(1)**. The **[Mod Analysis(1) Setup]** dialog box is displayed on the screen.
3. Data on frequency characteristics corrections, which is used to minimize Constellation Error of the signal source, can be calculated by touching the **[Make]** button of **[Equalizer Data]**.
4. To correct frequency characteristics, use the correction value calculated in the previous step. Set **[Correction Type]** to **[Equalizer]**.

4.2 Example of the Measurement that Uses the Equalizer Function

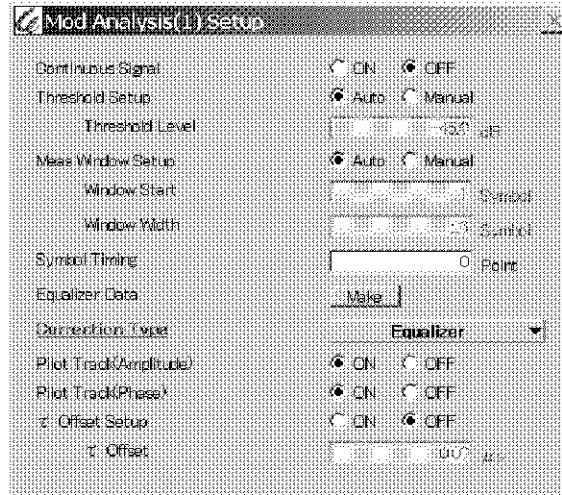

Figure 4-8 [Mod Analysis(1) Setup] Dialog Box when Using the Equalizer

5. Touch the **Close** key to close the dialog box.
6. Switch the signal path shown in Figure 4-7 to 2 and press the **SINGLE** key on the front panel.
The measurement results are displayed on the screen.

4.3 Modulation Analysis of a Continuous Wave

4.3 Modulation Analysis of a Continuous Wave

This section describes the procedure used for measuring a continuous signal. The signal must consist of frames that include the preamble.

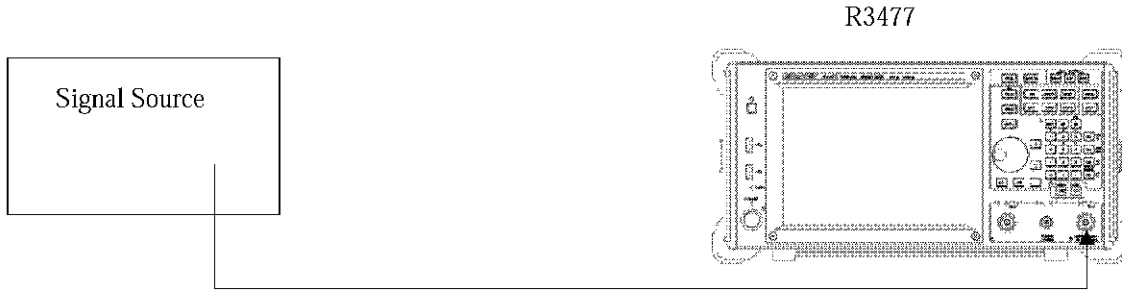

Figure 4-9 Connection Diagram for Modulation Analysis

Measurement condition setting

1. Press the **CONFIG** key and touch the **STD Setup** key.
2. Set **[Type]** in the **[STD Setup]** dialog box to **[WiBro16e_DL]**.
3. Touch the **Apply** key to apply the new setting.
4. Touch the **Tx Tester** key to select Tx Tester.
5. Press **FREQ**, **Center**, **2**, **3**, **5**, **0**, and **MHz**.
The center frequency is set to 2350 MHz.
6. Press the **FUNC** key and touch the **Modulation** key.
7. Touch **Trigger**, **Trigger Source**, and **Free Run**.
The measurement mode is set to internal trigger.
8. Touch the **Return** key twice to return to the Modulation menu.
9. Touch **Meas Mode** and **Modulation Analysis**.
10. Touch the **Return** key to return to the Modulation menu.
11. Touch the **Auto Level Set** key.
Ref Level is automatically set to the optimum value.
12. Touch **Meas Control**, **Meas Parameters**, and **Mod Analysis(1)**.
The **[Mod Analysis(1) Setup]** dialog box is displayed on the screen.
13. To measure a continuous signal, set **[Continuous Signal]** to **[ON]**.
14. Set the measurement window.
Enter the analysis starting position in **[Window Start]**. The symbol number of the preamble position is defined as 0.

15. Set the length of the measurement window.
Enter the analysis length in [**Window Width**] in symbol units.
16. Set the FFT position for demodulation.
To start the Fourier transform from the center of the guard interval, select [**Symbol Timing**] and press **0** and **Hz**(ENTER) on the keypad.
17. Select the correction type used when correcting frequency characteristics and performing the measurement.
To select the preamble correction type, set [**Correction Type**] to [**CH Est(Preamble)**].
18. Set whether to correct the amplitude for each OFDM symbol by using the pilot subcarrier.
To correct the amplitude by using the pilot subcarrier, set [**Pilot Track(Amplitude)**] to [**ON**].
19. Set whether to correct the phase for each OFDM symbol by using the pilot subcarrier.
To correct the phase by using the pilot subcarrier, set [**Pilot Track(Phase)**] to [**ON**].
20. Set [**τ Offset Setup**] to [**OFF**] because the offset cannot be added to the τ measurement result.

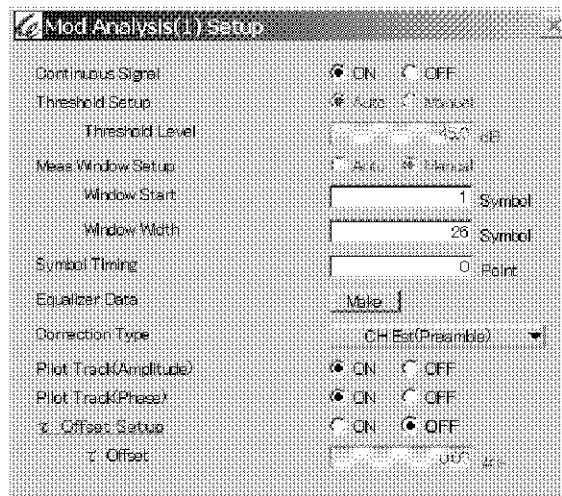

Figure 4-10 [Mod Analysis(1) Setup] Dialog Box

21. Touch the **Close** key to close the dialog box.
22. Touch the **Mod Analysis(2)** key.
The [**Mod Analysis(2) Setup**] dialog box is displayed on the screen.
23. To repeat the measurements for each frame, set [**Meas Condition**] to [**Frame**].
24. Set the number of frames to be calculated at any one time to 1.
Select [**Meas Frame Length**] and press **1** and **Hz**(ENTER) on the keypad.
25. Constellation Error Trigger is not used.
Set [**Constellation Error Trigger**] to [**OFF**].

4.3 Modulation Analysis of a Continuous Wave

26. Select a receiving filter.
Set **[Baseband Filter]** to **[Wide]**.

MEMO: Select a filter, whose bandwidth is wider enough than the signal bandwidth, assuming that no signal exists in adjacent channels. Press the key.

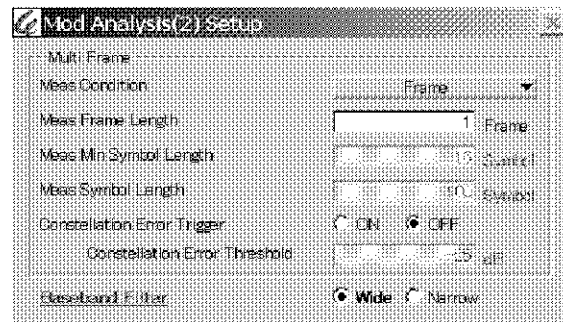

Figure 4-11 **[Mod Analysis(2) Setup]** Dialog Box

27. Touch the **Close** key to close the dialog box.
28. Touch the **Signal** key.
The **[Signal Setup]** dialog box is displayed on the screen.
29. Enter the signal cell ID.
Select **[Cell ID]** and press **0** and **Hz**(ENTER) on the keypad.
30. Enter the signal segment number.
Select **[Segment Number]** and press **0** and **Hz**(ENTER) on the keypad.
31. Set the subchannel type included in the signal.
Select **[PUSC+FUSC]** from **[Subchannel Type]**.
32. Set the number of PUSC subchannel symbols included in the signal.
Select **[Number of PUSC Symbol]** and press **1**, **2**, and **Hz**(ENTER) on the keypad.
33. Set "Permutation Base" of the signal.
Select **[DL PermBase]** and press **0** and **Hz**(ENTER) on the keypad.
34. Set "PRBS ID" of the signal.
Select **[PRBS_ID]** and press **0** and **Hz**(ENTER) on the keypad.

4.4 Ramp Measurement

4.4 Ramp Measurement

In the Ramp measurement, the rising edge and falling edge characteristics of the burst are displayed and whether they are in the range of the template that is compliant with the standard can be measured.



Figure 4-14 Connection Diagram for the Ramp Measurement

Measurement condition setting

1. Press the **CONFIG** key and touch the **STD Setup** key.
2. Set **[Type]** in the **[STD Setup]** dialog box to **[WiBro16e_DL]**.
3. Touch the **Apply** key to apply the new setting.
4. Touch the **Tx Tester** key and select Tx Tester.
5. Press **FREQ**, **Center**, **2**, **3**, **5**, **0**, and **MHz**.
The center frequency is set to 2350 MHz.
6. Press the **FUNC** key and touch the **Modulation**.
7. Touch **Trigger**, **Trigger Source**, and **Free Run**.
The measurement mode is set to internal trigger.
8. Touch the **Return** key twice to return to the Modulation menu.
9. Touch **Meas Mode** and **Ramp**.
10. Touch the **Return** key to return to the Modulation menu.
11. Touch the **Auto Level Set** key.
Ref Level is automatically set to the optimum value.
12. Touch **Meas Control**, **Meas Parameters**, and **Ramp**.
The **[Ramp Setup]** dialog box is displayed on the screen. Set the parameters used in the Ramp measurement in the **[Ramp Setup]** dialog box.
13. Set the length of the signal in **[Frame Length]** in symbol units.
14. Set the templates in Y0 to Y3 under **[Template]**.

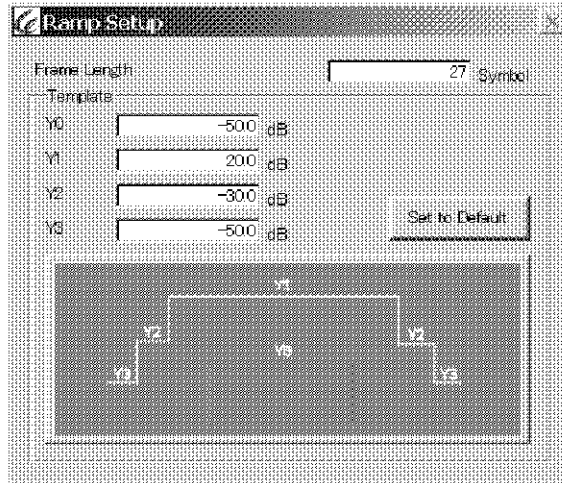

Figure 4-15 [Ramp] Dialog Box

15. Touch the **Close** key to close the dialog box.
16. Touch the **Signal** key.
The **[Signal Setup]** dialog box is displayed on the screen.
17. Enter the signal cell ID.
Select **[Cell ID]** and press **0** and **Hz** (ENTER) on the keypad.
18. Enter the signal segment number.
Select **[Segment Number]** and press **0** and **Hz** (ENTER) on the keypad.

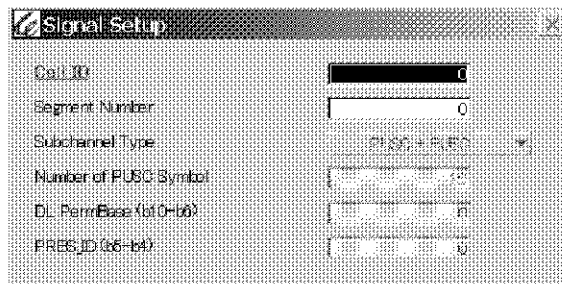

Figure 4-16 [Signal Setup] Dialog Box

19. Touch the **Close** key to close the dialog box.
20. Touch the **Return** key to return to the Meas Control menu.
21. Press the **SINGLE** key on the front panel or touch the **Single Meas** key on the soft menu bar. A Single measurement is performed and the measurement results are displayed on the screen.

4.4 Ramp Measurement

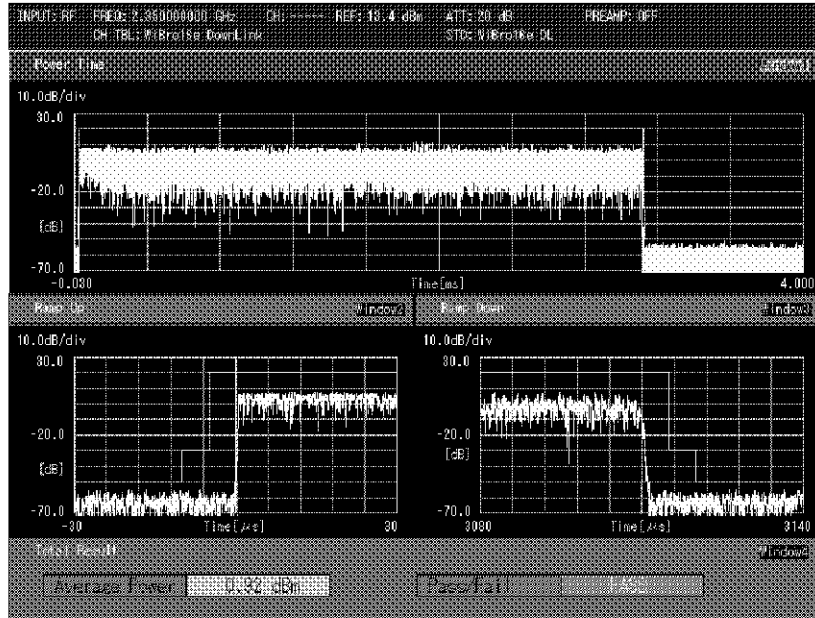



Figure 4-17 Ramp Measurement Results

22. To display a marker, touch a graph.
23. Press **MKR** and **Marker**.
A marker is displayed on the graph. The marker can be moved by using the knob.
24. Touch the **Delta Marker** key. A delta marker is displayed on the graph.

5. MENU MAP, FUNCTIONAL EXPLANATION

This chapter describes the configurations and functions of the soft keys displayed on the touch screen of the 3GPP (WiBro) analysis option.

MEMO:

- [.....] *Used to enclose a menu name, key name, item name in the dialog box, button name, or the name of selected items in lists and menus.*
-  *Shows a soft key on the soft menu bar.*

5.1 Menu Index

Operation Key	Pages	Operation Key	Pages
√Nyquist Filter On/Off	5-6, 5-7, 5-12, 5-16, 5-18	[Limit]	5-16
√Nyquist Filter Setup	5-7, 5-16, 5-18	Mag Error Spectrum	5-25
[All]	5-26, 5-27	[Mag Error Time]	5-24
[Apply]	5-26, 5-27	[Mag Flatness Spectrum]	5-25
Avg	5-26, 5-27	Mag Flatness Time	5-24
[Band Width]	5-16	[Meas Condition]	5-22
[Baseband Filter]	5-23	[Meas Frame Length]	5-22
Carrier Band Width	5-16	Meas Min Symbol Length	5-22
[Cell ID]	5-23	[Meas Symbol Length]	5-22
[Center Freq Error]	5-26	[Meas Window Setup]	5-21
Center Freq Error Time	5-24	No Display	5-24
[Channel Space]	5-16	[Number of PUSC Symbol]	5-23
[Constellation]	5-24	[Phase Error Spectrum]	5-25
Constellation Error Spectrum	5-25	Phase Error Time	5-24
[Constellation Error Threshold]	5-22	[Pilot Track(Amplitude)]	5-21
[Constellation Error Time]	5-24	[Pilot Track(Phase)]	5-22
Constellation Error Trigger	5-22	Power Spectrum	5-25
[Continuous Signal]	5-20	[Power Time]	5-24
[Correction Type]	5-21	[PRBS_ID]	5-23
Demodulated Data	5-26	RMS	5-26, 5-27
[DL PermBase]	5-23	[Segment Number]	5-23
[Equalizer Data]	5-21	[Set to Default]	5-23
Frame Length	5-23	Specified Subcarrier	5-26, 5-27
[Group Delay Spectrum]	5-24	[Specified Symbol]	5-27
[Integral BW Abs]	5-12	[Start]	5-12
Integral BW Rel	5-13	Stop	5-12
[Judge]	5-13	[Subchannel Type]	5-23
[Lim Abs Start]	5-13	[Symbol Timing]	5-21
Lim Abs Stop	5-13	τ Offset	5-22
[Lim Rel Start]	5-13	τ Offset Setup	5-22
Lim Rel Stop	5-13	[Template]	5-23
		Threshold Level	5-21
		[Threshold Setup]	5-20
		[Total Result]	5-25

5.1 Menu Index

[Window Start]	5-21	Edit Table	5-6, 5-14
[Window Width]	5-21	Ext1	5-8, 5-28
Abs Meas 1/2	5-7, 5-17	Ext2	5-8, 5-28
Abs Meas 2/2	5-7, 5-18	First Carrier Freq.	5-6, 5-14
ACLR	5-5, 5-7, 5-16	Format	5-8, 5-24
ACLR Off	5-7, 5-17	Free Run	5-8, 5-28
Auto Level Set	5-6, 5-7, 5-8, 5-9, 5-10, 5-11, 5-12, 5-14, 5-16, 5-17, 5-20, 5-29, 5-31, 5-32	FUNC	5-5
Average Mode Cont/Rep	5-6, 5-7, 5-9, 5-10, 5-11, 5-13, 5-17, 5-19, 5-30, 5-31	Gaussian On/Off	5-9, 5-32
Average Times On/Off	5-6, 5-7, 5-9, 5-10, 5-11, 5-13, 5-17, 5-19, 5-30, 5-31	IF Power	5-8, 5-28
Carrier Band Width	5-6, 5-12	Init	5-6, 5-7, 5-9, 5-13, 5-15, 5-16, 5-29
Carrier Freq	5-7, 5-18	Input	5-8, 5-28
CCDF	5-5, 5-9, 5-32	Insert	5-6, 5-7, 5-9, 5-13, 5-15, 5-16, 5-29
CCDF Gate On/Off	5-9, 5-32	IQ Inverse On/Off	5-8, 5-28
CCDF Off	5-9, 5-32	Judgment On/Off	5-6, 5-7, 5-9, 5-10, 5-11, 5-14, 5-15, 5-17, 5-19, 5-30, 5-31
CCDF RBW	5-9, 5-32	Last Carrier Freq.	5-6, 5-14
Channel Power	5-5, 5-6, 5-10	Limit	5-9, 5-31
Channel Power Off	5-6, 5-11	Lower Limit	5-6, 5-9, 5-10, 5-11, 5-30
Close	5-6, 5-7, 5-9, 5-13, 5-15, 5-16, 5-18, 5-22, 5-23, 5-26, 5-27, 5-30	Marker	5-33
Constellation	5-8, 5-27	Marker OFF	5-33
Copy from STD	5-7, 5-16	Marker Trace 1/2	5-33
Create Table	5-6, 5-14	Meas Control	5-8, 5-20
CS/BS Setup	5-7, 5-16	Meas Mode	5-8, 5-20
Delete	5-6, 5-7, 5-9, 5-13, 5-15, 5-16, 5-29	Meas Parameters	5-8, 5-20
Delta Marker On/Off	5-33	Meas Sample	5-9, 5-32
Display	5-8, 5-23	MKR	5-33
Dual Display	5-8, 5-27	Mod Analysis (1)	5-8, 5-20
		Mod Analysis (2)	5-8, 5-22
		Modulation	5-5, 5-8, 5-20
		Modulation Analysis	5-8, 5-20
		Modulation Off	5-8, 5-28
		Multi Carrier ACLR	5-5, 5-7, 5-17
		Multi Carrier ACLR Off	5-7, 5-19
		Next Result	5-6, 5-15
		Noise Corr On/Off	5-7, 5-17, 5-19
		OBW	5-5, 5-6,

	5-11	Spectrum Trace	5-8, 5-27
OBW Off	5-6, 5-11	Spurious Emissions	5-5, 5-6, 5-14
OBW%	5-6, 5-11	Spurious Emissions Off	5-6, 5-15
OFF Position	5-9, 5-31	Symbol Rate	5-6, 5-7, 5-12, 5-16, 5-19
OFF Width	5-9, 5-31	Table No. 1/2/3	5-6, 5-14, 5-15
Offset Setup	5-6, 5-12	T-Domain Power	5-5, 5-9, 5-29
ON Position	5-9, 5-31	T-Domain Power Off	5-9, 5-30
ON Width	5-9, 5-31	Template	5-9, 5-29
ON/OFF Ratio	5-5, 5-9, 5-31	Template Couple to Power On/Off	5-9, 5-30
ON/OFF Ratio Off	5-9, 5-31	Template Edit	5-9, 5-29
Peak Search	5-33	Template Limit	5-9, 5-30
Previous Result	5-6, 5-15	Template On/Off	5-9, 5-29
Quad Display	5-8, 5-27	Template Up/Low	5-9, 5-29
Ramp	5-8, 5-20, 5-23	Time Trace	5-8, 5-26
Ref Power Chan/Peak	5-6, 5-12	Trace Write On/Off	5-9, 5-32
Ref Power Setup	5-6, 5-12	Trigger	5-8, 5-28
Ref/Offs Setup	5-7, 5-17	Trigger Delay	5-8, 5-28
Rel Meas	5-7, 5-18	Trigger Slope +/-	5-8, 5-28
Repeat Meas	5-8, 5-20	Trigger Source	5-8, 5-28
Return	5-6, 5-7, 5-8, 5-9, 5-10, 5-12, 5-15, 5-16, 5-18, 5-19, 5-20, 5-23, 5-27, 5-28, 5-29, 5-30, 5-31	Upper Limit	5-6, 5-9, 5-10, 5-11, 5-30
Rolloff Factor	5-6, 5-7, 5-12, 5-16, 5-19	Window Format	5-8, 5-23
Scale	5-8, 5-27	Window On/Off	5-6, 5-9, 5-10, 5-29
Set to STD	5-6, 5-7, 5-9, 5-11, 5-14, 5-15, 5-17, 5-19, 5-30, 5-31	Window Position	5-6, 5-9, 5-10, 5-29
Shift X	5-9, 5-29	Window Setup	5-6, 5-9, 5-10, 5-29, 5-31
Shift Y	5-9, 5-29	Window Width	5-6, 5-9, 5-10, 5-29
Show Result	5-6, 5-15	X Scale Left	5-8, 5-27
Signal	5-8, 5-23	X Scale Max	5-9, 5-32
Single Display	5-8, 5-27	X Scale Right	5-8, 5-27
Single Meas	5-8	Y Scale Lower	5-8, 5-28
Sort	5-6, 5-7, 5-9, 5-13, 5-16, 5-29	Y Scale Upper	5-8, 5-28
Spectrum Emission Mask	5-5, 5-6, 5-12		
Spectrum Emission Mask Off	5-6, 5-14		

5.2 Switching Communication Systems

Press the **CONFIG** key and select Tx Tester from the soft menu to select the **Tx Tester** function.

Select the communication system, which is used for measuring from the dialog box that is displayed by pressing **STD Setup**.

5.3 Key Function Descriptions

This section describes the function of each key.

5.3.1 FUNC

Pressing the **FUNC** key displays the Function menu from which measurement functions can be selected.

The following shows the Function menu map:

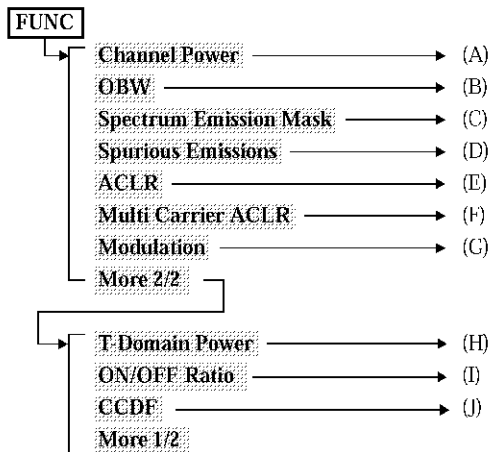

5.3.1 FUNC

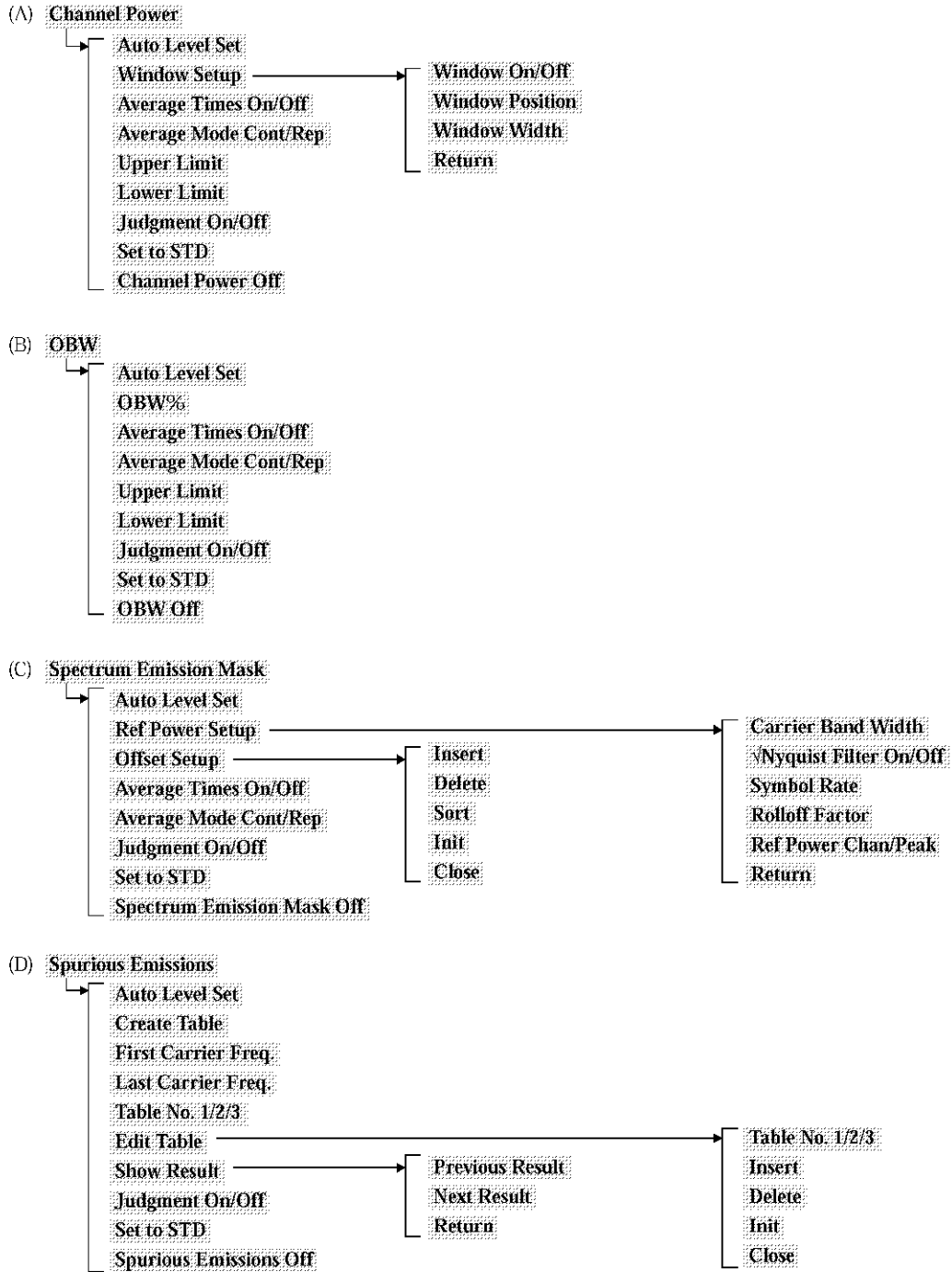

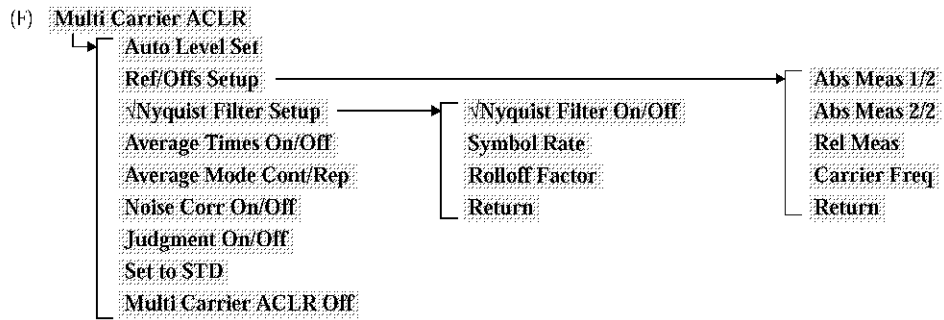
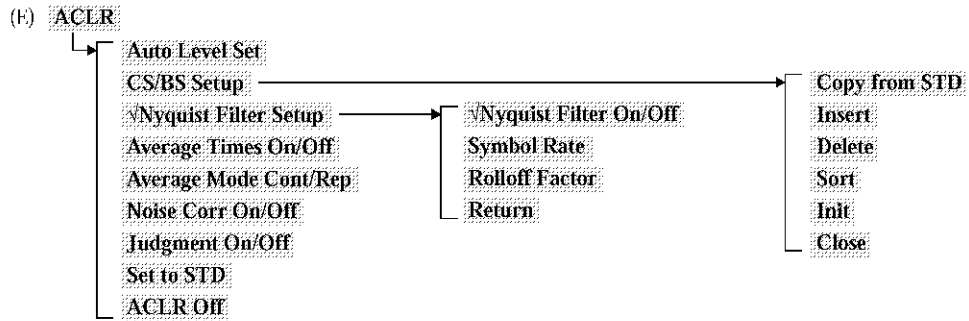

5.3.1 FUNC

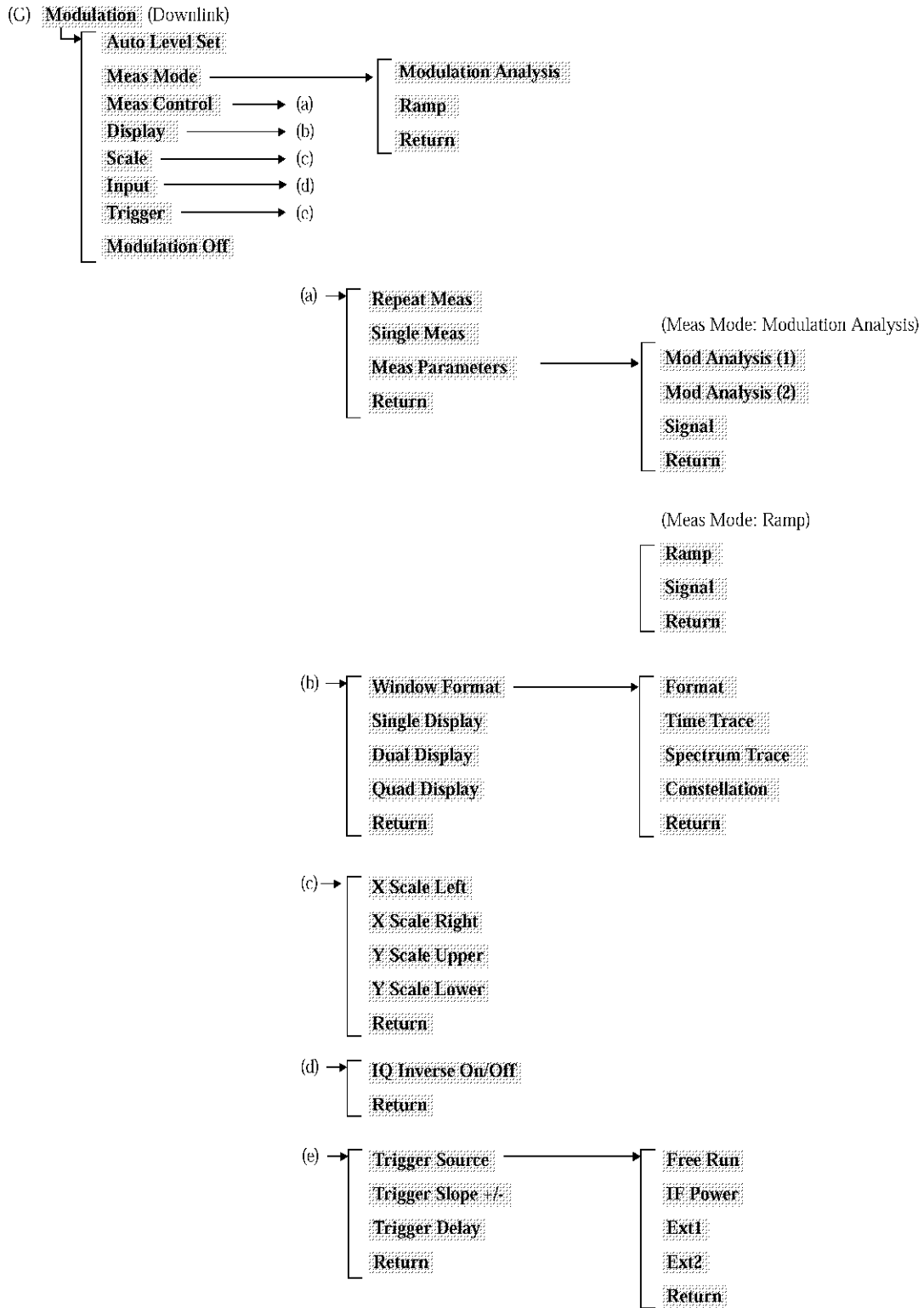

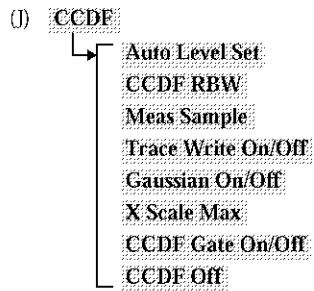
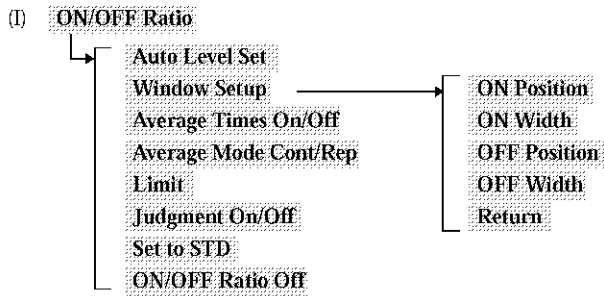
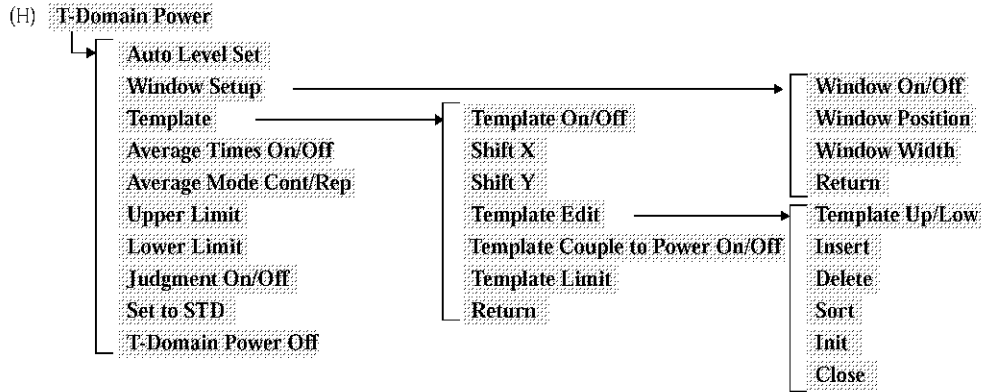

5.3.1 FUNC

5.3.1.1 CHANNEL POWER

Channel Power

Displays the Channel Power menu.
This menu is used to measure the power in the window or the power in the whole screen.

Auto Level Set

Sets the reference level and ATT to their optimum values according to the signal to be measured. When the key is pressed, Auto Level Set is executed.

Window Setup

Displays the Window Setup menu.

Window On/Off

Switches the measuring window On and Off.

On: Displays the measuring window on the screen.
The power in the window is measured.

Off: Hides the measuring window.
Measures the power in the whole screen.

Window Position

Sets the position of the measuring window.

Window Width

Sets the width of the measuring window.

Return

Returns to the previous menu.

Average Times On/Off

Switches the averaging function On and Off.

On: Sets the number of times averaging is performed in the channel power measurement and measures the average channel power.

Off: Cancels the averaging function.

Average Mode Cont/Rep

Switches the averaging mode between continuous calculation and repeat calculation.

Cont: Sets the continuous calculation mode.
In the continuous calculation mode, the moving-average method is used to calculate the average after the set averaging count is reached.

Rep: Sets the repeat calculation mode.
In the repeat calculation mode, when the set averaging count is reached, the current averaging count is reset to 1 and the averaging process is repeated from the beginning.

Upper Limit

Sets the upper limit that is used to judge whether the result is Pass or Fail.

Lower Limit

Sets the lower limit that is used to judge whether the result is Pass or Fail.

Judgment On/Off

Switches the judgment display On and Off.

“Pass” is displayed when [Lower Limit] ≤ Measurement result ≤ [Upper Limit]. Otherwise, “Fail” is displayed.

On: Displays the judgment.

Off: Hides the judgment.

Set to STD	Returns the measurement parameters to values that are compliant with the standard.
Channel Power Off	Quits the Channel Power measurement function.

5.3.1.2 OBW

OBW	Displays the OBW menu.
Auto Level Set	Sets the reference level and ATT to their optimum values according to the signal to be measured. When the key is pressed, Auto Level Set is executed.
OBW%	Sets the ratio, in percent, of the occupied bandwidth power to the total power.
Average Times On/Off	Switches the averaging function On and Off. On: Sets the number of times averaging is performed and averages the occupied bandwidth power. Off: Cancels the averaging function.
Average Mode Cont/Rep	Switches the averaging mode between continuous calculation and the repeat calculation. Cont: Sets the continuous calculation mode. In the continuous calculation mode, the moving-average method is used to calculate the average after the set averaging count is reached. Rep: Sets the repeat calculation mode. In the repeat calculation mode, when the set averaging count is reached, the current averaging count is reset to 1 and the averaging process is repeated from the beginning.
Upper Limit	Sets the upper limit that is used to judge whether the result is Pass or Fail.
Lower Limit	Sets the lower limit that is used to judge whether the result is Pass or Fail.
Judgment On/Off	Switches the judgment display On and Off. "Pass" is displayed when $[\text{Lower Limit}] \leq \text{Measurement result} \leq [\text{Upper Limit}]$. Otherwise, "Fail" is displayed. On: Displays the judgment. Off: Hides the judgment.
Set to STD	Returns the measurement parameters to values that are compliant with the standard.
OBW Off	Quits the OBW measurement function.

5.3.1 FUNC

5.3.1.3 SPECTRUM EMISSION MASK

Spectrum Emission Mask

Displays the Spectrum Emission Mask menu.

Auto Level Set

Sets the reference level and ATT to their optimum values according to the signal to be measured. When the key is pressed, Auto Level Set is executed.

Ref Power Setup

Displays the Ref Power menu. This menu is used to set the parameters which are used to calculate the reference power.

Carrier Band Width

Sets the power conversion bandwidth for carrier signals.

Nyquist Filter On/Off

Switches the Nyquist filter function ON and OFF.

ON: Sets the Nyquist filter.

OFF: Cancels the Nyquist filter.

Symbol Rate

Sets the inverse number of the symbol rate (frequency).

Rolloff Factor

Sets the roll-off factor.

Ref Power Chan/Peak

Switches the calculation mode of the reference power between the Channel mode and the Peak Power mode.

Chan: Calculates the carrier power according to the setting in **Ref Power Setup** and sets the result as the reference power for mask measurement.

Peak: Sets the Peak power value of the waveform as the reference power for the mask measurement.

Return

Returns to the previous menu.

Offset Setup

Displays the Offset Setup menu and the **[Offset Setup]** dialog box which is used to set Offset data.

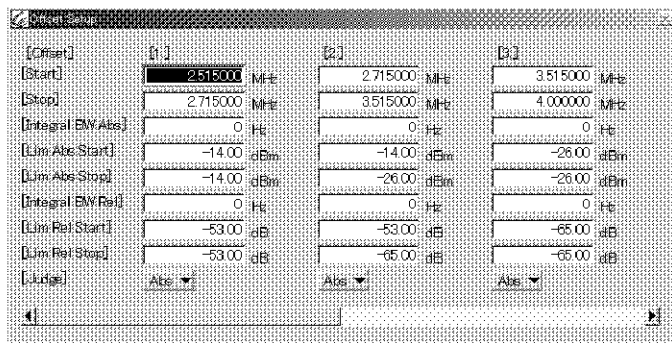

[Start]

Used to enter the offset frequency from the center frequency as the start frequency of the emission mask judgment range.

[Stop]

Used to enter the offset frequency from the center frequency as the stop frequency of the emission mask judgment range.

[Integral BW Abs]

Sets the power integral bandwidth at each frequency point in the absolute value measurement.

[Lim Abs Start]	Used to enter the mask value (in absolute values) at the start frequency.
[Lim Abs Stop]	Used enter the mask value (in absolute values) at the stop frequency. The mask value from the start frequency to the stop frequency is calculated by linearly interpolating between the start mask value and stop mask value.
[Integral BW Rel]	Sets the power integral bandwidth at each frequency point in the relative value measurement.
[Lim Rel Start]	Used to enter the mask value (in relative values) at the start frequency. The offset value from the measured reference power is compared with the mask value.
[Lim Rel Stop]	Used to enter the mask value (in relative values) at the stop frequency. The mask value from the start frequency to the stop frequency is calculated by linearly interpolating between the start mask value and stop mask value.
[Judge]	Specifies how to compare the waveform with the mask values (both absolute and relative) when judging whether the result is Pass or Fail. Abs: Compares the waveform with the mask values set in Limit Abs Start and Limit Abs Stop. If the waveform is equal to or less than the mask values, the result is Pass. Rel: Compares the waveform with the mask values set in Limit Rel Start and Limit Rel Stop. If the waveform is equal to or less than the mask values, the result is Pass. A&R: Compares the waveform with both the Limit Abs Start and Stop values and the limit Rel Start and Stop value. When both conditions are satisfied, Pass is displayed. A R: Compares the waveform with both the Limit Abs Start and Stop values and the Limit Rel Start and Stop values. When either of the conditions is satisfied, Pass is displayed.
Insert	Inserts a column that has the same values as the column at the cursor position.
Delete	Deletes the column at the cursor position.
Sort	Sorts the data in the dialog box in order of frequency.
Init	Deletes all data in the dialog box.
Close	Closes the dialog box and returns to the previous menu.
Average Times On/Off	Switches the averaging function On and Off. On: Sets the number of times averaging is performed in the spectrum emission mask measurement and performs the averaging measurement. Off: Cancels the averaging function.
Average Mode Cont/Rep	Switches the averaging mode between continuous calculation and repeat calculation.

5.3.1 FUNC

Cont: Sets the continuous calculation mode. In the continuous calculation mode, the moving-average method is used to calculate the average after the set averaging count is reached.

Rep: Sets the repeat calculation mode. In the repeat calculation mode, when the set averaging count is reached, the current averaging count is set to 1 and the averaging process is repeated from the beginning.

Judgment On/Off Switches the judgment display On and Off.

On: Displays the judgment.

Off: Hides the judgment.

Set to STD Returns the measurement parameters to values that are compliant with the standard.

Spectrum Emission Mask Off Quits the Spectrum Emission Mask measurement function.

5.3.1.4 SPURIOUS EMISSIONS

Spurious Emissions Displays the Spurious Emission menu.

Auto Level Set Measures the carrier power and sets the ATT in the setting sequence table to its optimum value according to the signal to be measured. When the key is pressed, Auto Level Set is executed. First Carrier Freq. and Last Carrier Freq. must be set before setting Auto Level Set.

Create Table Creates the setting sequence table that is compliant with the standard. The ATT settings in the table do not change. The contents of Table No.1 is created according to Category A. The contents of Table No.2 is created according to Category B. First Carrier Freq. and Last Carrier Freq. must be set before creating the table.

First Carrier Freq. Sets the carrier frequency. If the signal is a multi-carrier signal, the lowest carrier frequency is set.

Last Carrier Freq. Sets the carrier frequency. If the signal is a multi-carrier signal, the highest carrier frequency is set.

Table No. 1/2/3 Sets the setting sequence table number for the spurious measurement to 1, 2, or 3.

1: Sets table number 1.

2: Sets table number 2.

3: Sets table number 3.

Edit Table Displays the Edit Table menu. The [Edit Table] dialog box of the set table number is displayed. Parameters, which are used in the spurious measurement, such as start and stop frequencies, RBW, VBW, sweep time, reference level, attenuator, preamp, ON or OFF, and judgment level value can be set in the dialog box.

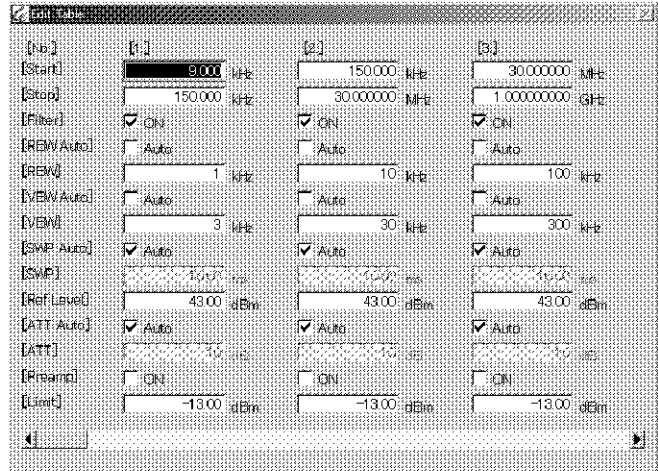
**Table No. 1/2/3**

Sets the setting sequence table number for the spurious measurement to 1, 2, or 3.

1: Sets table number 1.

2: Sets table number 2.

3: Sets table number 3.

Insert

Inserts a vertical column, in which spurious measurement conditions can be set, at the current cursor position. The data contained in the column that existed in the position before the column was inserted is copied to each setting value as new column data.

Delete

Deletes a column of measurement conditions from the current cursor position.

Init

Initializes all data in the table currently being edited.

Close

Closes the dialog box and returns to the previous menu.

Show Result

Displays the Show Result menu.
The measurement results are displayed.

Previous Result

Displays the previous screen.

Next Result

Displays the next screen.

Return

Closes the measurement result window and returns to the previous menu.

Judgment On/Off

Switches the judgment display On and Off.

On: Displays the judgment.

Off: Hides the judgment.

Set to STD

Returns the measurement parameters to values that are compliant with the standard.

Spurious Emissions Off

Quits the Spurious Emissions measurement function.

5.3.1 FUNC

5.3.1.5 ACLR

ACLR

Displays the ACLR menu.

Auto Level Set

Sets the reference level and ATT to their optimum values according to the signal to be measured. When the key is pressed, Auto Level Set is executed.

CS/BS Setup

Displays the CS/BS menu and **[CS/BS Setup]** dialog box.

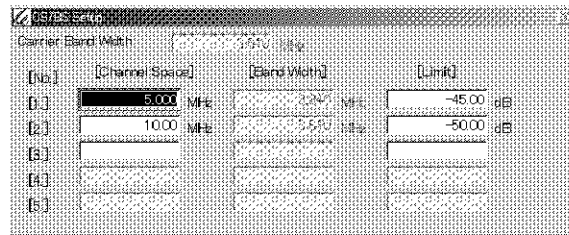

[Carrier Band Width]

Sets the measurement bandwidth in the channel power measurement which is used as the reference power.

[Channel Space]

Sets the offset frequency, which indicates the position at which the adjacent channel is measured, from the carrier frequency.

[Band Width]

Sets the measurement bandwidth in the adjacent channel leakage power measurement.

[Limit]

Sets the upper limit that is used to judge in the adjacent channel leakage power measurement.

Copy from STD

Returns the CS/BS Setup settings to values that are compliant with the standard.

Insert

Inserts a row in which the adjacent channel measurement conditions are set. The data on the row that existed in the position before the new row was inserted is copied to the new row.

Delete

Deletes the measurement condition from the current cursor position.

Sort

Sorts the data in the dialog box in order of frequency.

Init

Deletes all data in the table currently being edited.

Close

Closes the dialog box and returns to the previous menu.

√Nyquist Filter Setup

Displays the √Nyquist filter Setup menu.

√Nyquist Filter On/Off

Switches the Nyquist filter function ON and OFF.

On: Sets the Nyquist filter.

Off: Cancels the Nyquist filter.

Symbol Rate

Sets the inverse number of the symbol rate (frequency).

Rolloff Factor

Sets a roll-off factor.

Return

Returns to the previous menu.

Average Times On/Off	Switches the averaging function On and Off. On: Sets the number of times averaging is performed in the ACP measurement and measures the average adjacent channel leakage power. Off: Cancels the averaging function.
Average Mode Cont/Rep	Switches the averaging mode between continuous calculation and the repeat calculation. Cont: Sets the continuous calculation mode. In the continuous calculation mode, the moving-average method is used to calculate the average after the set averaging count is reached. Rep: Sets the repeat calculation mode. In the repeat calculation mode, when the averaging count is reached, the current averaging count is reset to 1 and the averaging process is repeated from the beginning.
Noise Corr On/Off	Performs a correction equivalent to the internal noise level of this instrument and switches On and Off the expansion function of the measurement dynamic range. On: Turns on the noise correction function. Every time the measurement parameters change, the internal noise level of this instrument is measured and the noise correction value is reflected in the measured value. Off: Turns off the noise correction function.
Judgment On/Off	Switches the judgment display On and Off. On: Displays the judgment. Off: Hides the judgment.
Set to STD	Returns the measurement parameters to values that are compliant with the standard.
ACLR Off	Quits the ACLR measurement function.

5.3.1.6 MULTI CARRIER ACLR

Multi Carrier ACLR	Displays the Multi Carrier ACLR menu.
Auto Level Set	Sets the reference level and ATT to their optimum values according to the signal to be measured. When the key is pressed, Auto Level Set is executed.
Ref/Offs Setup	Displays the Ref/Offs Setup menu.
Abs Meas 1/2	Displays the [Abs Meas 1/2] dialog box. Sets the offset frequency and bandwidth of the reference carrier. Set the offset frequency from the center frequency that is used before the measurement. Up to ten carriers can be set by also setting [Abs Meas 2/2].

5.3.1 FUNC

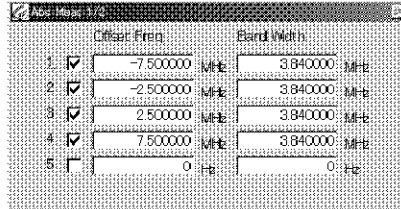

Close

Closes the dialog box and returns to the previous menu.

Abs Meas 2/2

Displays the [Abs Meas 2/2] dialog box.

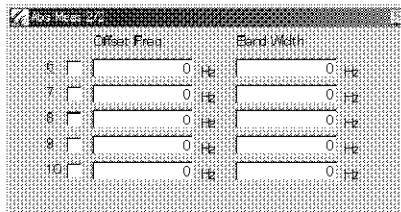

Close

Closes the dialog box and returns to the previous menu.

Rel Meas

Displays the [Rel Meas] dialog box. The frequencies and band-widths of up to six waves in the frequency range in which ACLR is measured can be set. The frequency to be measured is set the frequency offset from the set reference carrier frequency.

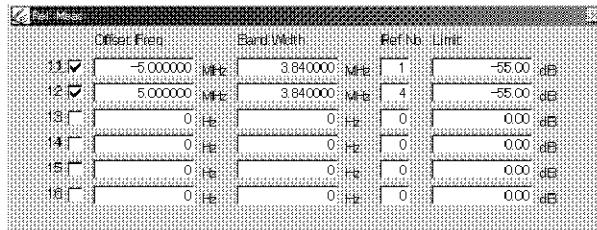

Close

Closes the dialog box and returns to the previous menu.

Carrier Freq

Displays the [Carrier Freq] dialog box. The center frequency that is used as the reference in Multi Carrier ACLR can be adjusted.



Close

Closes the dialog box and returns to the previous menu.

Return

Returns to the previous menu.

Nyquist Filter Setup

Displays the Nyquist filter Setup menu.

Nyquist Filter On/Off

Switches the Nyquist filter function ON and OFF.

	On:	Sets the Nyquist filter.
	Off:	Cancels the Nyquist filter.
Symbol Rate		Sets the inverse number of the symbol rate (frequency).
Rolloff Factor		Sets a roll-off factor.
Return		Returns to the previous menu.
Average Times On/Off		Switches the averaging function On and Off.
	On:	Sets the number of times averaging is performed in the multi-carrier ACP measurement and measures the average adjacent channel leakage power.
	Off:	Cancels the averaging function.
Average Mode Cont/Rep		Switches the averaging mode between continuous calculation and the repeat calculation.
	Cont:	Sets the continuous calculation mode. In the continuous calculation mode, the moving-average method is used to calculate the average after the set averaging count is reached.
	Rep:	Sets the repeat calculation mode. In the repeat calculation mode, when the averaging count is reached, the current averaging count is reset to 1 and the averaging process is repeated from the beginning.
Noise Corr On/Off		Performs the correction equivalent to the internal noise level of this instrument and switches On and Off the expansion function of the measurement dynamic range.
	On:	Turns on the noise correction function. Every time the measurement parameters change, the internal noise level of this instrument is measured and the noise correction value is reflected in the measured value.
	Off:	Turns off the noise correction function.
Judgment On/Off		Switches the judgment display On and Off.
	On:	Displays the judgment.
	Off:	Hides the judgment.
Set to STD		Returns the measurement parameters to values that are compliant with the standard.
Multi Carrier ACLR Off		Quits the Multi Carrier ACLR measurement function.

5.3.1 FUNC

5.3.1.7 MODULATION (Downlink)

Modulation	Displays the Modulation menu.
Auto Level Set	Sets the reference level to its optimum value according to the measured signal. When the key is pressed, Auto Level Set is executed.
<hr/>	
IMPORTANT: While Auto Level Set is being executed, the level of the measured signal must remain constant.	
<hr/>	
Meas Mode	Displays the Meas Mode menu, which is used to select a measurement mode.
Modulation Analysis	Selects the modulation analysis function.
Ramp	Selects the function that measures the rising and falling edges of a signal.
Return	Returns to the previous layer menu.
Meas Control	Displays the Meas Control menu where measurement conditions are set.
Repeat Meas	Performs repeated measurements. This menu functions as the START key. If the conditions set in the Meas Parameters menu are satisfied when Modulation Analysis is selected from the Meas Mode menu, the number of measurement symbols returns to 0 and a new measurement begins.
Single Meas	Performs a single measurement. This menu functions as the SINGLE key. If the conditions set in the Meas Parameters menu are satisfied when Modulation Analysis is selected from the Meas Mode menu, the measurement is complete.
Meas Parameters	Displays the Meas Parameters menu.
Mod Analysis (1)	Displays the dialog box that contains the measurement parameters used in the modulation analysis.
[Continuous Signal]	Set whether the signal is a continuous wave or a burst wave. ON: Analyzes the continuous wave. OFF: Analyzes the burst signal.
<hr/>	
IMPORTANT: When a continuous wave is analyzed, Window Start and Window Width must be in the frame range of the continuous wave. Otherwise incorrect measurement results may be acquired.	
<hr/>	
[Threshold Setup]	When the burst wave is analyzed, the frame in A/D data is detected based on the threshold level. In Threshold Level Setup, the method to set the threshold level can be changed.

Auto: Automatically sets the threshold level.

Manual: Manually sets the threshold level.

[Threshold Level]

This menu is enabled when Threshold Setup is set to Manual. Sets the threshold level.

[Meas Window Setup]

Selects the method to set the measurement symbol range.

Auto: Automatically sets the measurement symbol range so that all data symbols in the frame are in the measurement range.

Manual: Manually sets the measurement symbol range.

[Window Start]

Sets the start position in the measurement symbol range by using a symbol number when Meas Window Setup is set to Manual. The first preamble is treated as symbol 0.

[Window Width]

Sets the length of the measurement symbol range by using a symbol number when Meas Window Setup is set to Manual.

[Symbol Timing]

Sets the start position in the range, which is used for the FFT (demodulation) in the OFDM symbol. The position, which is found by adding 1/2 of the guard interval to the beginning of the OFDM symbol, is 0.

[Equalizer Data]

Creates equalizer data. After the frame analysis, press the **[Make]** button. Equalizer data, which corrects the frequency characteristics (amplitude and phase), is calculated.

IMPORTANT: Frame analysis must be completed before Equalizer data can be calculated.

[Correction Type]

Selects the method used to correct frequency characteristics.

Equalizer: Corrects the frequency characteristics by using the equalizer data. To use this function, the equalizer data must have been previously created.

CH Estimation (Preamble):

Corrects the frequency characteristics by using channel correction data which is estimated from the preamble.

CH Estimation (Pilot):

Corrects the frequency characteristics by using channel correction data which is estimated from the pilot subcarrier.

OFF: Does not correct the frequency characteristics.

[Pilot Track(Amplitude)]

Sets whether to correct the amplitude for each symbol by using the pilot subcarrier.

ON: Corrects the amplitude for each symbol.

5.3.1 FUNC

OFF: Does not correct the amplitude for each symbol.

[Pilot Track(Phase)]

Sets whether to synchronize the phase for each symbol by using the pilot subcarrier.

ON: Corrects the phase for each symbol.

OFF: Does not corrects the phase for each symbol.

[τ Offset Setup] To correct the time offset, sets whether to add the time offset to the τ measurement result and display τ .

ON: Displays τ after adding the time offset to the τ measurement result.

OFF: Displays τ without adding the time offset to the τ measurement result.

[τ Offset] This menu is enabled when τ Offset Setup is set to ON. Sets the time offset.

Close

Closes the dialog box and returns to the previous layer menu.

Mod Analysis (2)

Displays the dialog box that contains measurement conditions used in the modulation analysis.

[Meas Condition]

Sets measurement conditions.

Frame: Measures the set number of Frames.

Symbol: Measures the set number of Symbols.

Frame & Min Symbol:

Measures the set number of Frames. However, any Frame whose number of symbols is less than Min Symbol is not measured.

[Meas Frame Length]

Sets the required number of frames

[Meas Min Symbol Length]

Sets the minimum number of symbols required for one frame in the Total Result measurement.

[Meas Symbol Length]

Sets the number of symbols required for the Total Result measurement.

[Constellation Error Trigger]

Sets whether to halt measurement if Constellation Error exceeding the set Constellation Error Threshold value is detected.

ON: Uses the Constellation Error Trigger function.

OFF: Does not use the Constellation Error Trigger function.

MEMO: *If this function halts the measurement, the message "EVM fail stop." is displayed.*

[Constellation Error Threshold]

This menu is enabled when Constellation Error Trigger is set to ON. Sets the threshold level used to halt measurement.

[Baseband Filter]

Selects a baseband filter bandwidth.

Wide: Selects a filter whose bandwidth is wider than the bandwidth of the carrier. The high speed measurement can be performed. However, if signals exist in adjacent channels, measurements cannot be performed.

Narrow: Selects a filter whose bandwidth is equal to the bandwidth of the carrier. Even if signals exist in adjacent channels, measurements can be performed, but they take time.

NOTE: *If signals exist in adjacent channels, select Narrow.*

Close

Closes the dialog box and returns to the previous layer menu.

Ramp

Displays the dialog box that contains the measurement parameters used to measure the rising and falling edges of a frame.

[Frame Length] Sets the signal frame length.

[Template] Sets the template.

[Set to Default] Returns the template settings to their default values.

Close

Closes the dialog box and returns to the previous layer menu.

Signal

Displays the dialog box that contains the signal information settings.

[Cell ID] Sets the signal Cell ID.

[Segment Number]
Sets the signal Segment Number.

[Subchannel Type]
Selects Subchannel Type.

PUSC only: Sets Subchannel Type to PUSC only.

PUSC + FUSC: Sets Subchannel Type to PUSC + FUSC.

FUSC only: Sets Subchannel Type to FUSC only.

[Number of PUSC Symbol]
Sets the PUSC length in symbol units.

[DL PermBase] Sets the signal DL PermBase.

[PRBS_ID] Sets the signal PRBS_ID.

Close

Closes the dialog box and returns to the previous layer menu.

Return

Returns to the previous layer menu.

Return

Returns to the previous menu.

Display

Displays the Display setting menu.

Window Format

Sets how the active window is displayed on the screen. The display type is selected from **Format**. The details are set in **Time Trace**, **Spectrum Trace**, or **Constellation** depending on the display type that is selected.

5.3.1 FUNC

- Format** Displays the dialog box for selecting the active window display type.
- [Constellation Error Time]** Displays Constellation Error for each symbol on a graph. On the graph, the vertical axis shows Constellation Error (dB) and the horizontal axis shows time (symbol). The Constellation Error RMS value trace, Constellation Error value of any one of the subcarriers, or Constellation Error value plot of all symbols or subcarriers can be displayed.
- [Mag Error Time]** Displays Magnitude Error for each symbol on a graph. On the graph, the vertical axis shows Magnitude Error (dB) and the horizontal axis shows time (symbol). The Magnitude Error RMS value trace, Magnitude Error value trace of any one of the subcarriers, or Magnitude Error value plot of all symbols or subcarriers can be displayed.
- [Phase Error Time]** Displays Phase Error for each symbol on a graph. On the graph, the vertical axis shows Phase Error (deg) and the horizontal axis shows time (symbol). The Phase Error average value trace, Phase Error value trace of any one of the subcarriers, or Phase Error value plot of all symbols or subcarriers can be displayed.
- [Mag Flatness Time]** Displays Magnitude Flatness for each symbol on a graph. On the graph, the vertical axis shows Magnitude Flatness (dB) and the horizontal axis shows time (symbol). The Magnitude Flatness average value trace, Magnitude Flatness value trace of any one of the subcarriers, or Magnitude Flatness value plot of all symbols or subcarriers can be displayed.
- [Power Time]** Displays the power for each symbol on a graph. On the graph, the vertical axis shows power (dBm) and the horizontal axis shows time (symbol). The symbol power average value trace, power value trace of any one of the subcarriers, or power value plot of all symbols or subcarriers can be displayed.
- [Constellation]** Displays the constellation. On the graph, the vertical axis shows the magnitude of the I signal and the horizontal axis shows the magnitude of the Q signal. Constellations of all symbols or subcarriers, the constellation of any one of the subcarriers, or the constellation of any one of the symbols can be displayed.
- [Center Freq Error Time]** Displays the center frequency error for each symbol on a graph. On the graph, the vertical axis shows the frequency error (Hz) and the horizontal axis shows time (symbol). The center frequency error trace and the average value can be displayed.
- [Group Delay Spectrum]** Displays the group delay for each subcarrier on a graph. On the graph, the vertical axis shows Group Delay and the horizontal axis shows the frequency (subcarrier). The group delay is calculated from the phase difference.
- [No Display]** Displays nothing.

[Constellation Error Spectrum]

Displays Constellation Error for each subcarrier on a graph. On the graph, the vertical axis shows Constellation Error (dB) and the horizontal axis shows the frequency (subcarrier). The Constellation Error RMS value trace, Constellation Error value trace of any one of the symbols, or Constellation Error value plot of all symbols or subcarriers can be displayed.

[Mag Error Spectrum]

Displays Magnitude Error for each subcarrier on a graph. On the graph, the vertical axis shows Magnitude Error (dB) and the horizontal axis shows the frequency (subcarrier). The Magnitude Error RMS value trace, EVM value trace of any one of the symbols, or Magnitude Error value plot of all symbols or subcarriers can be displayed.

[Phase Error Spectrum]

Displays Phase Error for each subcarrier on a graph. On the graph, the vertical axis shows Phase Error (deg) and the horizontal axis shows the frequency (subcarrier). The Phase Error average value trace, Phase Error value trace of any one of the symbols, or Phase Error value plot of all symbols or subcarriers can be displayed.

[Mag Flatness Spectrum]

Displays Magnitude Flatness for each subcarrier on a graph. On the graph, the vertical axis shows Magnitude Flatness (dB) and the horizontal axis shows the frequency (subcarrier). The Magnitude Flatness average value trace, Magnitude Flatness value trace of any one of the symbols, or Magnitude Flatness value plot of all symbols or subcarriers can be displayed.

[Power Spectrum]

Displays the power for each subcarrier on a graph. On the graph, the vertical axis shows the power (dBm) and the horizontal axis shows the frequency (subcarrier). The subcarrier power average value trace, power value trace of any one of the symbols, or power value plot of all symbols or subcarriers can be displayed.

[Total Result] Displays the total of the measurement values of all frames for the chips in the measurement range as the result.

- Cnst Error(dB, %): RMS value of Constellation Error
- Mag Error(dB, %): RMS value of Magnitude Error
- Phase Error(deg): RMS value of Phase Error
- Frequency Error(Hz, ppm): Center Frequency Error
- Power (dBm, W, dBm/MHz, W/MHz): Power
- Flatness(dB): Spectral Flatness
- Leak-Power (dB): Center Frequency Leakage Power
(Total power ratio)
- Lk-SubCarAvg (dB): Center Frequency Leakage Power
(Sub carrier average power ratio)
- Number

Meas Symbol: Number of symbols to be measured

Meas Frame: Number of frames to be measured

5.3.1 FUNC

A/D Capture: Number of A/D data captures

[Demodulated Data]

The demodulated data on the signal measured is displayed. It is displayed for each symbol and subcarrier in a hexadecimal number respectively. The subcarrier type and the modulation system are distinguished by color. The demodulated data on the first 10 symbols (when the dual or quad display is selected) or the first 24 symbols (when the single display is selected) in the measurement range is displayed on the screen. To see the demodulated data on the subsequent symbols, change the measurement range.

QPSK: green

16QAM: light blue

64QAM: pink

Pilot: yellow

When there are no subcarriers, red asterisks (**) are displayed.

[Spectrogram]

Displays the spectrogram. Displays the time change of the spectrum of the measurement signal. The vertical axis shows time (symbol) and the horizontal axis shows frequency (subcarrier). The color shows the power strength.

Close

Closes the dialog box and returns to the previous layer menu.

Time Trace

Sets the result graph that has a horizontal axis showing time (symbol). The checked items are displayed on the graph. Multiple items can be selected.

[RMS]

Displays the RMS value of the measurement result on a trace.

NOTE: *RMS can be selected only for Constellation Error and Magnitude Error.*

[Avg]

Displays the average value of the measurement result on a trace.

NOTE: *Avg can be selected only for Phase Error, Magnitude Flatness, Power, and Center Freq Error.*

[Specified Subcarrier]

Sets the subcarrier number to be displayed on a graph.

NOTE: *This cannot be selected for Center Freq Error.*

[Apply]

Applies the specified subcarrier number.

[All]

Displays measurement values of all subcarriers for each symbol on a plot.

NOTE: *This cannot be selected for Center Freq Error.*

[Center Freq Error]

Displays the center frequency error of each symbol on a trace.

Close	Closes the dialog box and returns to the previous layer menu.
Spectrum Trace	Sets the result graph that has a horizontal axis showing frequency (subcarrier). The checked items are displayed on the graph. Multiple items can be selected.
[RMS]	Displays the RMS value of the measurement result on a trace.
<hr/>	
<i>NOTE: RMS can be selected only for Constellation Error and Magnitude Error.</i>	
<hr/>	
[Avg]	Displays the average value of the measurement result on a trace.
<hr/>	
<i>NOTE: Avg can be selected only for Phase Error, Magnitude Flatness, and Power.</i>	
<hr/>	
[Specified Symbol]	Sets the symbol number to be displayed on a graph.
[Apply]	Applies the specified symbol number.
[All]	Displays measurement values of all symbols for each subcarrier on a plot.
Close	Closes the dialog box and returns to the previous layer menu.
Constellation	Performs setup related to the constellation display. The checked items are displayed. Only one item can be selected at a time.
[Specified Subcarrier]	Displays the constellation of any one of the subcarriers.
[Apply]	Applies the specified subcarrier number.
[Specified Symbol]	Displays the constellation of any one of the symbols.
[Apply]	Applies the specified symbol number.
[All]	Displays the constellations of all symbols and subcarriers.
Close	Closes the dialog box and returns to the previous layer menu.
Return	Returns to the previous layer menu. This cannot be selected for Center Freq Error.
Single Display	Selects the single display.
Dual Display	Selects the dual display.
Quad Display	Selects the quad display.
Return	Returns to the previous layer menu.
Scale	Displays the Scale menu used for setting the X-axis and Y-axis scales in the active display window.
X Scale Left	Sets the minimum value on the X axis.
X Scale Right	Sets the maximum value on the X axis.

5.3.1 FUNC

Y Scale Upper	Sets the maximum value on the Y axis.
Y Scale Lower	Sets the minimum value on the Y axis.
Return	Returns to the previous layer menu.
Input	Displays the Input menu.
IQ Inverse On/Off	Sets whether to invert the phase of the input signal in measurement. ON: Inverts the phase. OFF: Does not invert the phase.
Return	Returns to the previous layer menu.
Trigger	Displays the Trigger menu.
Trigger Source	Displays the Trigger Source menu.
Free Run	Acquires and analyzes data according to internal timing.
IF Power	Acquires and analyzes data in synchronization with the IF signal.
Ext1	Acquires and analyzes data in synchronization with the external signal entered into the EXT TRIG IN 1 connector. The threshold level in Ext1 is fixed at the TTL level.
Ext2	Acquires and analyzes data in synchronization with the external signal entered into the EXT TRIG IN 2 connector. The threshold level in Ext2 can be set.
Return	Returns to the previous layer menu.
Trigger Slope +/-	Switches the polarity of the trigger slope between plus and minus. This menu is only enabled when Trigger Source is set to IF Power, Ext1, or Ext2. +: Synchronizes the sweep start with the rising edge of a trigger. -: Synchronizes the sweep start with the falling edge of a trigger.
Trigger Delay	Sets the delay time from a trigger point. This menu is only enabled when Trigger Source is set to IF Power, Ext1, or Ext2. The start position for capturing the A/D data when performing the analysis is shifted for the delay time.
Return	Returns to the previous layer menu.
Modulation Off	Terminates the Modulation measurement function.

5.3.1.8 T-Domain Power

T-Domain Power	Displays the T-Domain Power menu. In the T-domain Power measurement function, the average power at the zero-span setting is measured. The template and the displayed waveform can be compared and judged.
Auto Level Set	Sets the reference level to its optimum value according to the signal to be measured. When this key is pressed, Auto Level Set is executed.
Window Setup	Displays the Window Setup menu.
Window On/Off	Switches the measuring window display On and Off. On: Displays the measuring window on the screen. Measures the average power in the window. Off: Hides the measuring window. Measures the average power in the whole screen.
Window Position	Sets the position of the measuring window.
Window Width	Sets the width of the measuring window.
Return	Returns to the previous menu.
Template	Displays the Template menu.
Template On/Off	Switches the template display On and Off. On: Displays the template and the result is judged comparing to the template. Off: Hides the template and the result is not judged comparing to the template.
Shift X	Sets the distance by which the template is moved in the X-axis direction.
Shift Y	Sets the distance by which the template is moved in the Y-axis direction.
Template Edit	Displays the Template Edit menu and the Template Edit dialog box.
Template Up/Low	Switches the templates to be edited. Up: Edits the template of the upper limit value. Low: Edits the template of the lower limit value.
Insert	Inserts a row that has the same values as the row at the cursor position.
Delete	Deletes a row.
Sort	Sorts the data in the template in ascending order.
Init	Deletes all data in the template currently being edited.

5.3.1 FUNC

Close	Closes the dialog box and returns to the previous menu.
Template Couple to Power On/Off	Sets whether to couple the template display to the measured power. On: Couples the template display to the measured power. The template set by the relative level to the measured power is displayed. Off: Does not couple the template display to the measured power. The template set by the absolute level is displayed.
Template Limit	Sets the lower limit value of the template when Template Couple to Power is set to On.
Return	Returns to the previous menu.
Average Times On/Off	Switches the averaging function in the power measurement On and Off. On: Sets the number of times averaging is performed in the power measurement and measures the average power. Off: Cancels the averaging function.
Average Mode Cont/Rep	Switches the averaging mode between continuous calculation and repeat calculation. Cont: Sets the continuous calculation mode. In the continuous calculation mode, the moving-average method is used to calculate the average after the set averaging count is reached. Rep: Sets the repeat calculation mode. In the repeat calculation mode, when the set averaging count is reached, the current averaging count is reset to 1 and the averaging process is repeated from the beginning.
Upper Limit	Sets the upper limit value that is used to judge whether the result is Pass or Fail.
Lower Limit	Sets the lower limit value that is used to judge whether the result is Pass or Fail.
Judgment On/Off	Switches the judgment display On and Off. "Pass" is displayed when [Lower Limit] ≤ measurement result ≤ [Upper Limit]. Otherwise, "Fail" is displayed. On: Displays the judgment. Off: Hides the judgment.
Set to STD	Returns the measurement parameters to values that are compliant with the standard.
T-Domain Power Off	Quits the T-domain Power measurement function.

5.3.1.9 ON/OFF Ratio

ON/OFF Ratio

Displays the ON/OFF Ratio menu.
In the ON/OFF Ratio measurement function, the power ratio of the ON period to the OFF period of the burst signal is measured.

Auto Level Set

Sets the reference level to its optimum value according to the signal to be measured.
When this key is pressed, Auto Level Set is executed.

Window Setup

Displays the Window Setup menu.

ON Position

Sets the start position of the ON period in the burst signal.

ON Width

Sets the width of the ON period in the burst signal.

OFF Position

Sets the start position of the OFF period in the burst signal.

OFF Width

Sets the width of the OFF period in the burst signal.

Return

Returns to the previous menu.

Average Times On/Off

Switches the averaging function On and Off.

On: Sets the number of times averaging is performed and measures the average power.

Off: Cancels the averaging function.

Average Mode Cont/Rep

Switches the averaging mode between continuous calculation and repeat calculation.

Cont: Sets the continuous calculation mode.
In the continuous calculation mode, the moving-average method is used to calculate the average after the set averaging count is reached.

Rep: Sets the repeat calculation mode.
In the repeat calculation mode, when the set averaging count is reached, the current averaging count is reset to 1 and the averaging process is repeated from the beginning.

Limit

Sets the limit value that is used to judge whether the result is Pass or Fail.

Judgment On/Off

Switches the judgment display On and Off.
"Pass" is displayed when $[\text{Limit}] \leq \text{measurement result}$. Otherwise, "Fail" is displayed.

On: Displays the judgment.

Off: Hides the judgment.

Set to STD

Returns the measurement parameters to values that are compliant with the standard.

ON/OFF Ratio Off

Quits the ON/OFF Ratio measurement function.

5.3.1 FUNC

5.3.1.10 CCDF

CCDF	Displays the CCDF menu. The screen changes to the CCDF measurement screen.
Auto Level Set	Sets the reference level and ATT to the optimum value in accordance with the signal to be measured. When the key is pressed, Auto Level Set is executed.
CCDF RBW	Sets RBW. RBW can be set to a range of 100 kHz to 10 MHz (1 and 3 sequence) and 20 MHz.
Meas Sample	Sets the number of measurement samples.
Trace Write On/Off	Switches the reference waveform display On and Off. On: Displays the currently-displayed waveform as the reference waveform. Off: Hides the reference waveform.
Gaussian On/Off	Switches the ideal Gaussian noise waveform display On and Off. On: Displays the ideal Gaussian noise waveform. Off: Hides the ideal Gaussian noise waveform.
X Scale Max	Sets the maximum value of the horizontal axis on the waveform display.
CCDF Gate On/Off	Switches the gate function of the CCDF measurement On and Off. On: Sets a threshold level and performs the CCDF measurement in the period where the input signal is higher than the specified threshold level. Off: Cancels the gate function of the CCDF measurement.
CCDF Off	Quits the CCDF measurement function.

5.3.2 MKR

In the Modulation measurement function of the Tx Tester mode, the dedicated Marker menu is displayed by pressing the MKR key.

This section describes the Marker menu in the Modulation measurement and its functions.

The Marker menu can be used when the graph screen is selected.

5.3.2.1 MKR (MODULATION - Downlink)

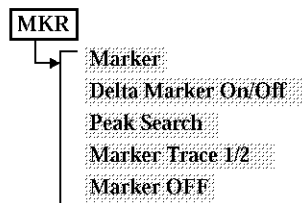

Marker

Displays a marker and sets the marker position.

Delta Marker On/Off

Switches the delta marker display function On and Off.

On: Displays the delta marker and normal marker in the same position. Displays the relative value to the normal marker in the marker area.

Off: Deletes the display of the delta marker.

Peak Search

Moves the marker to the maximum peak on a trace.

Marker Trace 1/2

Selects a trace on which to display the normal marker when multiple traces exist.

Marker OFF

Deletes the marker.

6. SCPI COMMAND REFERENCE

This chapter describes the SCPI command reference for this instrument.

6.1 Command Reference Format

This section describes the format and layout used to describe commands in this chapter.

Each description includes the following items:

Function description

SCPI command

Parameter

Query reply

- [Function description]
The usage of commands and operations in this instrument.
- [SCPI command]
The SCPI command displays the syntax of a command sent from the external controller to this instrument. The syntax consists of a command and a number of parameters. The command and the parameters are separated by a space.
If a command has multiple parameters, they are separated by commas (.). The three points (...) displayed between commas represent the parameter(s) omitted at that position.
For example, the description <numeric value 1>, ..., <numeric value 4> shows that four parameters, <numeric value 1>, <numeric value 2>, <numeric value 3>, and <numeric value 4>, are required.
If the parameter is a character string type such as <character string>, <character string 1>, the parameter must be enclosed in double quotation marks (" "). If the parameter is <block>, it shows the block format data.

Text written in lowercase alphabetic characters in the syntax can be omitted.

For example, ":CALibration:CABLe" can be abbreviated to ":CAL:CABL."

The marks used in the syntax are defined as follows:

- < >: Shows a parameter required for sending a command
- []: Shows that the command is optional
It can be omitted
- { }: Shows that only one item is required to be selected from multiple items
- |: Used as a delimiter for multiple items written in curly brackets {..}
- <screen>: Written in the command header and shows the target screen number of the command
The screen number can be omitted. However, when it is written, a value from 1 to 4 can be selected
{1|2|3|4}

For example, If the syntax below is specified, :CALC:CORR:EDEL:TIME 0.1 and :CALCULATE1:SELECTED:CORR:EDEL:TIME 25E-3 are valid.

Syntax: CALCulate{[1|2|3|4]}[:SElected]:CORRection:EDELay:TIME <numeric value>

6.1 Command Reference Format

- [Parameter]

Describes a parameter required for sending a command.

If the parameter is numeric type or alphabetic, it is enclosed in angle brackets (< >).

If the parameter is optional, it is enclosed in curly brackets ({ }).

In this manual, parameter types are described in the following formats:

< int >: A numeric value that can be input in the format NR1, NR2, or NR3 and rounded to an integer in this instrument

< real >: A numeric value that can be input in the format NR1, NR2, or NR3 and rounded to a valid-digit real number in this instrument

< bool >: Either OFF or ON can be entered.

< str >: A character string enclosed in quotation (' ') or double quotation (" ") marks.

<block>: Block data type
The data content is an 8-bit binary data array

< type >: Character data selected from multiple types

- [Query reply]

When there is a query reply to the command, the data format used for reading the query is described.

Each parameter to be read is enclosed in curly brackets ({ }). If multiple items, which are delimited by a vertical bar (|), exist in curly brackets ({ }), only one of those items is read out. If parameters are delimited by commas (,) multiple parameters can be read out. The three points (...) displayed between commas represent data omitted from that position. For example, the description {numeric value 1},..., {numeric value 4} shows that four parameters {numeric value 1}, {numeric value 2}, {numeric value 3}, and {numeric value 4} are read.

If the parameter to be read is enclosed in square brackets ([]), the parameter may be omitted, depending on the measurement result, etc.

If the parameter to be read is a value in a unit, a description such as "Unit: dBm" is added to display the unit of the parameter value. However, only when the parameter is described in a level unit "dBm", the level unit selected at that time will be applied to the parameter.

6.2 Common Commands

This section describes common IEEE commands.

Function description	SCPI Command	Parameter	Query reply	Remarks
Clears the status byte and related data	*CLS	-	-	
Sets the standard event status enable register	*ESE	<int>	<int>	
Reads the standard event status register	*ESR?	-	<int>	
Device inquiry	*IDN?	-	<str>	*1
Notice of completion of all running operations	*OPC	-	1	
Loads the device settings	*RCL	<int> POFF	-	*2
Resets the device	*RST	-	-	
Saves the device settings	*SAV	<int>	<int>	
Sets the service request enable register	*SRE	<int>	<int>	
Reads the status byte register	*STB?	-	<int>	
Triggers the device	*TRG	-	-	
Waits for the completion of all running operations	*WAI	-	-	

*1 <str> is output in the following format: maker name, model name, serial number and version number.

*2 POFF indicates the parameter settings at the last power-off

6.3 Modulation Analysis Commands (Downlink)

6.3 Modulation Analysis Commands (Downlink)

6.3.1 Subsystem-INPut

Function description	SCPI command	Parameter	Query reply	Remarks
ATT(Manual)	:INPut:ATTenuation	<real>	<real>	
ATT(Auto/Manual)	:INPut:ATTenuation:AUTO	OFF ON	OFF ON	
Min ATT	:INPut:ATTenuation:MINimum	<real>	<real>	
Min ATT ON/OFF	:INPut:ATTenuation:MINimum:STATe	OFF ON	OFF ON	
Prcamp ON/OFF	:INPut:GAIN:STATe	OFF ON	OFF ON	
IQ Inverse ON/OFF	:INPut:IQ:INVerse	OFF ON	OFF ON	

6.3.2 Subsystem-CONFigure

Function description	SCPI command	Parameter	Query reply	Remarks
Meas Mode				
Modulation Analysis	:CONFigure:MANalysis	-	-	
Ramp	:CONFigure:RAMp	-	-	

6.3.3 Subsystem-SENSE

Function description	SCPI command	Parameter	Query reply	Remarks
Center Freq	[:SENSe]:FREQuency:CENTer	<real>	<real>	
Freq Offset	[:SENSe]:FREQuency:OFFSet	<real>	<real>	
Freq Offset ON/OFF	[:SENSe]:FREQuency:OFFSet:STATe	OFF ON	OFF ON	
Channel Number	[:SENSe]:FREQuency:CHANnel:NUMBer	<int>	<int>	
Executing the Auto Level Set	[:SENSe]:POWer:LEVel:AUTO	--	--	
Meas Parameters (Mod Analysis 1)				
Continuous Signal	[:SENSe]:CONDition:CSIGnal	OFF ON	OFF ON	
Threshold Level	[:SENSe]:CONDition:THReshold	<real>	<real>	
Threshold Setup	[:SENSe]:CONDition:THReshold:AUTO	OFF ON	OFF ON	
Meas Window Setup	[:SENSe]:CONDition:MWINdow:AUTO	OFF ON	OFF ON	
Window Start	[:SENSe]:CONDition:MWINdow:STARt	<int>	<int>	
Window Width	[:SENSe]:CONDition:MWINdow:WIDTh	<int>	<int>	
Symbol Timing	[:SENSe]:CONDition:STIMing	<int>	<int>	
Creating the Equalizing Filter	[:SENSe]:CONDition:EQUALizer:MAKE	--	--	
Correction Type	[:SENSe]:CONDition:CTYPe	OFF EQUALizer CEPRamble CEPilot	OFF EQUA CEPR CEP	
Pilot Track (Amplitude)	[:SENSe]:CONDition:PTRack:AMPLitude	OFF ON	OFF ON	
Pilot Track (Phase)	[:SENSe]:CONDition:PTRack:PHASe	OFF ON	OFF ON	
τ Offset	[:SENSe]:CONDition:TAU:OFFSet	<real>	<real>	
τ Offset Setup	[:SENSe]:CONDition:TAU:OFFSet:STATe	OFF ON	OFF ON	
Meas Parameters (Mod Analysis 2)				
Meas Condition	[:SENSe]:CONDition:MCONDition	FRAME FMSymbol SYMBOL	FRAME FMSY SYMB	
Symbol Length	[:SENSe]:CONDition:SLENgth	<int>	<int>	
Frame Length	[:SENSe]:CONDition:MANalysis:FLENgth	<int>	<int>	
Minimum Symbol Length	[:SENSe]:CONDition:MSLEngh	<int>	<int>	
Constellation Error Threshold	[:SENSe]:CONDition:CETRigger	<real>	<real>	
Constellation Error Trigger	[:SENSe]:CONDition:CETrigger:STATe	OFF ON	OFF ON	
Baseband Filter	[:SENSe]:CONDition:BBFilter	WIDE NARRow	WIDE NARR	

6.3.3 Subsystem-SENSE

Function description	SCPI command	Parameter	Query reply	Remarks
Meas Parameters (Ramp)				
Frame Length	[:SENSE]:CONDition:RAMP:FLENgth	<int>	<int>	
Template Level (ALL)	[:SENSE]:CONDition:TEMPlate:LEVel:ALL	<real1>,<real2>,<real3>,<real4>	<real1>,<real2>,<real3>,<real4>	*1
Template Level (Y0 to Y3)	[:SENSE]:CONDition:TEMPlate:LEV<lv=1 2 3 4>	<real>	<real>	
Template Level Default	[:SENSE]:CONDition:TEMPlate:DEFault	--	--	
Meas Parameters (Signal)				
Cell ID	[:SENSE]:CONDition:ID:CELL	<int>	<int>	
Segment Number	[:SENSE]:CONDition:SNUMBER	<int>	<int>	
Subchannel Type	[:SENSE]:CONDition:SCType	PON1.y P#FUSC FON1.y	PON1. P#FUSC FON1.	
Number of PUSC Symbol	[:SENSE]:CONDition:PSYMBOL:NUMBER	<int>	<int>	
DL PermBase	[:SENSE]:CONDition:DLPBase	<int>	<int>	
PRBS_ID	[:SENSE]:CONDition:ID:PRBS	<int>	<int>	

*1: <real1> = Y0
 <real2> = Y1
 <real3> = Y2
 <real4> = Y3

6.3.4 Subsystem-MEASure/READ/FETCH

MEMO: *The reply formats of the Measure, Read, and Fetch commands are the same. The difference between the Measure, Read, and Fetch commands is that the Measure and Read commands are used to execute measurements and the Fetch command is used only to read result data. Both the Measure and Read commands execute measurements. However, the initialization processes for the commands when entering the measurement mode are different. The differences are described in the function description given later. If no descriptions are given, the initialization processes are the same. If the Fetch command is issued without entering the corresponding measurement mode, a Query error occurs.*

Function description	SCPI command	Parameter	Query reply	Remarks
Total Result (Mod)				
Constellation Error	:MEASure:TRESult:CERRor?	--	<real1>,<real2>	*1
Peak Constellation Error	:MEASure:TRESult:PCERRor?	--	<real1>,<real2>, <int1>,<int2>	*2
Magnitude Error	:MEASure:TRESult:MERRor?	--	<real1>,<real2>	*3
Phase Error	:MEASure:TRESult:PFERRor?	--	<real>	
Frequency Error	:MEASure:TRESult:FERRor?	--	<real1>,<real2>	*4
Transmit Power	:MEASure:TRESult:POWer?	--	<real1>,<real2>, <real3>,<real4>	*5
τ	:MEASure:TRESult:TAU?	--	<real>	
Spectral Flatness	:MEASure:TRESult:FLATness :NUMBer{1 2 3 4} ?	--	<int1>,<int2>, <real1>,<real2>, <real3>[,...]	*6

- *1 <real1> = Constellation Error: Unit: dB, <real2> = Constellation Error: Unit: %
- *2 <real1> = Constellation Error: Unit: dB, <real2> = Constellation Error: Unit: %,
<int1> = Subcarrier, <int2> = Symbol
- *3 <real1> = Mag Error: Unit: dB, <real2> = Mag Error: Unit: %
- *4 <real1> = Frequency Error: Unit: Hz, <real2> = Frequency Error: Unit: ppm
- *5 <real1> = Transmit Power: Unit: dBm, <real2> = Transmit Power: Unit: dBm/MHz,
<real3> = Transmit Power: Unit: W, <real4> = Transmit Power: Unit: W/MHz
- *6 When the NUMBer header is omitted:<int1>,<int2>,<real1>,<real2>,<real3>,<int3>,<int4>,<real4>,<real5>,<real6>,
<int5>,<int6>,<real7>,<real8>,<real9>, <int7>,<int8>,<real10>,<real11>,<real12>
 <int1> = Start subcarrier number, <int2> = Stop subcarrier number
 <real1> = Flatness(Max): Unit: dB, <real2> = Flatness(Min): Unit: dB, <real3> = Flatness(Avg): Unit: dB
 <int3> = Start subcarrier number, <int4> = Stop subcarrier number
 <real4> = Flatness(Max): Unit: dB, <real5> = Flatness(Min): Unit: dB, <real6> = Flatness(Avg): Unit: dB
 <int5> = Start subcarrier number, <int6> = Stop subcarrier number
 <real7> = Flatness(Max): Unit: dB, <real8> = Flatness(Min): Unit: dB, <real9> = Flatness(Avg): Unit: dB
 <int7> = Start subcarrier number, <int8> = Stop subcarrier number
 <real10> = Flatness(Max): Unit: dB, <real11> = Flatness(Min): Unit: dB, <real12> = Flatness(Avg): Unit: dB
 When the NUMBer header is specified:<int1>,<int2>,<real1>,<real2>,<real3>
 <int1> = Start subcarrier number, <int2> = Stop subcarrier number
 <real1> = Flatness(Max): Unit: dB, <real2> = Flatness(Min): Unit: dB, <real3> = Flatness(Avg): Unit: dB

6.3.5 Subsystem-INITiate

Function description	SCPI command	Parameter	Query reply	Remarks
Center Frequency Leakage	:MEASure:TRESult:LEAKage?	--	<real1>,<real2>	*7
Center Frequency Leakage (Overall)	:MEASure:TRESult:LEAKage:OPower?	--	<real>	
Center Frequency Leakage (Average Power)	:MEASure:TRESult:LEAKage:APower?	--	<real>	
Meas Number	:MEASure:TRESult:NUMBER?	--	<int1>,<int2>,<int3>	*8
Meas Symbol Number	:MEASure:TRESult:NUMBER:SYMBOL?	--	<int>	
Meas Frame Number	:MEASure:TRESult:NUMBER:FRAME?	--	<int>	
Meas A/D Capture Number	:MEASure:TRESult:NUMBER:CAPTURE?	--	<int>	
Total Result (Ramp)				
Average Power & Pass/Fail	:MEASure:TRESult:RAMP:ALL?	--	<real>, PASS FAIL	
Average Power	:MEASure:TRESult:RAMP:APower?	--	<real>	
Pass/Fail	:MEASure:TRESult:RAMP:FAIL?	--	PASS FAIL	

*7 <real1> = Leakage (ratio for overall power): Unit: dB,

<real2> = Leakage (ratio for subcarrier average power): Unit: dB

*8 <int1> = Meas Symbol Number, <int2> = Meas Frame Number, <int3> = Meas A/D Capture Number

6.3.5 Subsystem-INITiate

Function description	SCPI command	Parameter	Query reply	Remarks
Executing the Single measurement	:INITiate:MEASure:SINGLE	--	--	
Executing the Repeat measurement	:INITiate:MEASure:REPeat	--	--	
Stopping the measurement	:INITiate:ABORt	--	--	

6.3.6 Subsystem-TRIGGER

Function description	SCPI command	Parameter	Query reply	Remarks
Trigger Source	:TRIGGER[:SEQUENCE]:SOURCE	IMMEDIATE IF EXTERNAL1 EXTERNAL2	IMM IF EXT1 EXT2	*1
Trigger Slope	:TRIGGER[:SEQUENCE]:SLOPE	POSITIVE NEGATIVE	POS NEG	
IF Power Trigger Level	:TRIGGER[:SEQUENCE]:LEVEL:IF	<real>	<real>	
Ext2 Trigger Level	:TRIGGER[:SEQUENCE]:LEVEL:EXTERNAL	<real>	<real>	
Trigger Delay	:TRIGGER[:SEQUENCE]:DELAY	<real>	<real>	

*1:

IMMEDIATE: Free-run status where no trigger is set

IF: IF trigger

EXT1: EXT1 input signal trigger

EXT2: EXT2 input signal trigger

6.3.7 Subsystem-DISPLAY

Function description	SCPI command	Parameter	Query reply	Remarks
Ref Level	:DISPLAY:TRACE:Y[:SCALE]:RLEVEL	<real>	<real>	
Level Offset	:DISPLAY:TRACE:Y[:SCALE]:RLEVEL:OFFSET	<real>	<real>	
Level Offset ON/OFF	:DISPLAY:TRACE:Y[:SCALE]:RLEVEL:OFFSET:STATE	OFF ON	OFF ON	
Multi Screen	:DISPLAY	SINGLE DUAL QUAD	SING DUAL QUAD	
Switching to the active screen to display the measurement results	:DISPLAY:ACTIVE	<int>	<int>	
Selecting the Analysis Format	:DISPLAY[:WINDOW<scrn=1 2 3 4>]:TRACE:FORMAT	OFF SPECTrogram TRF Sul CF Spectrum CETime MESpectrum METime PFSpectrum PETime MFSpectrum MFTIME CONStellation CF Time PSPpectrum PTIME DDATa GDSPpectrum	OFF SPEC TRES CESP CET MESP MF T PFS PET MFSP MF T CONS CFET PSP PTIM DDAT GDSP	
Time Trace RMS ON/OFF	:DISPLAY[:WINDOW<scrn=1 2 3 4>]:TRACE:TIME:RMS	OFF ON	OFF ON	
Time Trace AVG ON/OFF	:DISPLAY[:WINDOW<scrn=1 2 3 4>]:TRACE:TIME:AVERage	OFF ON	OFF ON	
Time Trace Specified Sub-carrier ON/OFF	:DISPLAY[:WINDOW<scrn=1 2 3 4>]:TRACE:TIME:SSUBcarrier	OFF ON	OFF ON	

6.3.7 Subsystem-DISPLAY

Function description	SCPI command	Parameter	Query reply	Remarks
Time Trace Specified Sub-carrier Number	:DISPlay[:WINDow<scrn=1 2 3 4>]:TRACe:TIME:SSUBcarrier:NUMBER	<int>	<int>	
Time Trace All Measurement Value Plot ON/OFF	:DISPlay[:WINDow<scrn=1 2 3 4>]:TRACe:TIME:PLOT:ALL	OFF ON	OFF ON	
Time Trace Center Freq Error ON/OFF	:DISPlay[:WINDow<scrn=1 2 3 4>]:TRACe:TIME:CFERror	OFF ON	OFF ON	
Spectrum Trace RMS ON/OFF	:DISPlay[:WINDow<scrn=1 2 3 4>]:TRACe:SPECtrum:RMS	OFF ON	OFF ON	
Spectrum Trace AVG ON/OFF	:DISPlay[:WINDow<scrn=1 2 3 4>]:TRACe:SPECtrum:AVERAge	OFF ON	OFF ON	
Spectrum Trace Specified Symbol ON/OFF	:DISPlay[:WINDow<scrn=1 2 3 4>]:TRACe:SPECtrum:SSYMBOL	OFF ON	OFF ON	
Spectrum Trace Specified Symbol Number	:DISPlay[:WINDow<scrn=1 2 3 4>]:TRACe:SPECtrum:SSYMBOL:NUMBER	<int>	<int>	
Spectrum Trace All Measurement Value Plot ON/OFF	:DISPlay[:WINDow<scrn=1 2 3 4>]:TRACe:SPECtrum:PILOT:ALL	OFF ON	OFF ON	
Constellation Trace	:DISPlay[:WINDow<scrn=1 2 3 4>]:TRACe:CONStellation	ALL SUBCarrier SYMBOL	ALL SUBC SYM3	
Constellation Specified Sub-carrier Number	:DISPlay[:WINDow<scrn=1 2 3 4>]:TRACe:CONStellation:SSUBcarrier:NUMBER	<int>	<int>	
Constellation Specified Symbol Numbe	:DISPlay[:WINDow<scrn=1 2 3 4>]:TRACe:CONStellation:SSYMBOL:NUMBER	<int>	<int>	
X Scale Left	:DISPlay[:WINDow<scrn=1 2 3 4>]:TRACe:X[:SCALE]:LEFT	<real>	<real>	
X Scale Right	:DISPlay[:WINDow<scrn=1 2 3 4>]:TRACe:X[:SCALE]:RIGHT	<real>	<real>	
Y Scale Upper	:DISPlay[:WINDow<scrn=1 2 3 4>]:TRACe:Y[:SCALE]:UPPer	<real>	<real>	
Y Scale Lower	:DISPlay[:WINDow<scrn=1 2 3 4>]:TRACe:Y[:SCALE]:LOWer	<real>	<real>	
X Scale Left (Ramp)	:DISPlay:RAMP[:WINDow<scrn=1 2 3>]:TRACe:X[:SCALE]:LEFT?	--	<real>	
X Scale Right (Ramp)	:DISPlay:RAMP[:WINDow<scrn=1 2 3>]:TRACe:X[:SCALE]:RIGHT?	--	<real>	
Y Scale Upper (Ramp)	:DISPlay:RAMP[:WINDow<scrn=1 2 3>]:TRACe:Y[:SCALE]:UPPer	<real>	<real>	
Y Scale Lower (Ramp)	:DISPlay:RAMP[:WINDow<scrn=1 2 3>]:TRACe:Y[:SCALE]:LOWer	<real>	<real>	

6.3.8 Subsystem-MMEMory

Function description	SCPI command	Parameter	Query reply	Remarks
Specifying the device used when executing the SAVE and LOAD functions.	:MMEMory:DEVIce	C D E	C D E	*1
Saving the settings of this instrument	:MMEMory:STORe:STATe	<int>	--	*2
Loading the settings of this instrument	:MMEMory:LOAD:STATe	<int>	--	*2
Selecting whether to save the measurement conditions	:MMEMory:SElect:ITEM:WIBROHEXEDI.:SEtup	OFF ON	OFF ON	

*1: The following devices are specified depending on the parameter:

C C:\MyData\SVRCL
 D D:\ADVANTEST
 E E:\ADVANTEST

2: A number, which is a maximum of 4-digit and is added to the file name of the data to be saved or loaded, must be specified in <int>.

6.3.9 Subsystem-SYSTEM

Function description	SCPI command	Parameter	Query reply	Remarks
Selecting the measurement system	:SYSTem:SElect	SANalyzer TXTester	SAN TXT	
Setting the measurement standard	:SYSTem:SElect:STANdard	<str1>,<str2>	--	*1
Initializing each measurement system parameter	:SYSTem:PRESet	--	--	
Initializing all measurement systems	:SYSTem:PRESet:ALL	--	--	
Inquiring about the most recent error	:SYSTem:ERRor?	--	<int>,<str>	*2
Inquiring about the error log	:SYSTem:ERRor:ALL?	--	<int>,<str>	*2
Inquiring about the R3477 series options	:SYSTem:OPTions?	--	<str> ...	

*1: In <str1>, the standard name is set. In <str2>, the operating band name is set.

For this option, use the following settings:

<str1> = "WiBro16c_DL", <str2> = "WiBro16c_DL"

To specify user data, set the following:

<str1> = "STD_USER"

<str2> = "file name"

Specify "OFF" instead of <str1> and <str2> when setting the standard to OFF.

:SYSTem:SElect:STANdard OFF

*2: In <int>, the error number is returned. In <str>, a character string of the error message is returned.

6.4 Other Commands

6.4 Other Commands

6.4.1 Subsystem-INPut

Function description	SCPI command	Parameter	Query reply	Remarks
ATT (Manual)	:INPut:ATTenuation	<real>	<real>	
ATT(Auto/Manual)	:INPut:ATTenuation:AUTO	OFF ON	OFF ON	
Min ATT	:INPut:ATTenuation:MINimum	<real>	<real>	
Min ATT ON/OFF	:INPut:ATTenuation:MINimum:STATe	OFF ON	OFF ON	
Prcamp ON/OFF	:INPut:GAIN:STATe	OFF ON	OFF ON	

6.4.2 Subsystem-SENSE

Function description	SCPI command	Parameter	Query reply	Remarks
Frequency				
Setting the Center Freq	[[:SENSE]:FREQUENCY:CENTer	<real>	<real>	
Setting the Start Freq	[[:SENSE]:FREQUENCY:START	<real>	<real>	
Setting the Stop Freq	[[:SENSE]:FREQUENCY:STOP	<real>	<real>	
Setting the Span	[[:SENSE]:FREQUENCY:SPAN	<real>	<real>	
Setting the Center Freq setting resolution	[[:SENSE]:FREQUENCY:CENTer:STEP	<real>	<real>	
Setting the Center Freq setting resolution mode	[[:SENSE]:FREQUENCY:CENTer:STEP:AUTO	OFF ON	OFF ON	
Setting the Offset Freq	[[:SENSE]:FREQUENCY:OFFSet	<real>	<real>	
Setting the Offset Freq condition	[[:SENSE]:FREQUENCY:OFFSet:STATe	OFF ON	OFF ON	
Setting the channel number	[[:SENSE]:FREQUENCY:CHANnel:NUMBER	<int>	<int>	
Band Width				
Setting the RBW	[[:SENSE]:{BANDwidth BWIDth}:RESolution]	<real>	<real>	
Setting the RBW mode	[[:SENSE]:{BANDwidth BWIDth}:RESolution]:AUTO	OFF ON	OFF ON	
Setting the VBW	[[:SENSE]:{BANDwidth BWIDth}:VIDeo	<real>	<real>	
Setting the VBW setting mode	[[:SENSE]:{BANDwidth BWIDth}:VIDeo:AUTO	OFF ON	OFF ON	
Setting the ratio between the span and the RBW	[[:SENSE]:{BANDwidth BWIDth}:RESolution]:RATio	<real>	<real>	
Setting the ratio mode between the span and the RBW	[[:SENSE]:{BANDwidth BWIDth}:RESolution]:RATio:STATe	OFF ON	OFF ON	
Setting the ratio between the RBW and the VBW	[[:SENSE]:{BANDwidth BWIDth}:VIDeo:RATio	<real>	<real>	
Setting the ratio mode between the RBW and the VBW	[[:SENSE]:{BANDwidth BWIDth}:VIDeo:RATio:STATe	OFF ON	OFF ON	
Couple				
Setting an automatic coupling	[[:SENSE]:COUPLE:ALL:AUTO	--	--	
ADC				
Setting the ADC Dither	[[:SENSE]:ADC:DITHer	OFF ON	OFF ON	
Detector				
Setting the trace detector	[[:SENSE]:DETECTOR:TRACe:FUNCTION	NORMAL POSitive NEGative SAMPLE AVERAGE	NORM POS NEG SAMP AVER	
Selecting the trace detector mode	[[:SENSE]:DETECTOR:TRACe:FUNCTION:AUTO	OFF ON	OFF ON	

6.4.2 Subsystem-SENSE

Function description	SCPI command	Parameter	Query reply	Remarks
Average				
Setting the average mode of the average detector	[:SENSE]:AVERAge:TYPE	RMS VIDeo VOLTage	RMS VID VOLT	
Setting the mode used when selecting the average detection mode of the average detector	[:SENSE]:AVERAge:TYPE:AUTO	OFF ON	OFF ON	
Preselector				
Manually adjusting the pre-selector	[:SENSE]:PRESelector	<int>	<int>	
Automatically adjusting the pre-selector	[:SENSE]:PRESelector:AUTO	--	--	
Sweep				
Setting the sweep time	[:SENSE]:SWEep:TIME	<real>	<real>	
Selecting the sweep time setting mode	[:SENSE]:SWEep:TIME:AUTO	OFF ON	OFF ON	
Specifying the number of times the sweep averaging is performed and the number of times MAX HOLD is performed.	[:SENSE]:SWEep:COUNt	<int>	<int>	
Setting the gated sweep to ON or OFF	[:SENSE]:SWEep:GATE	OFF ON	OFF ON	
Setting the gate signal position	[:SENSE]:SWEep:GATE:DELAy	<real>	<real>	
Setting the gate signal width	[:SENSE]:SWEep:GATE:WIDTh	<real>	<real>	
Switching the gate signal mode	[:SENSE]:SWEep:GATE:WIDTh:AUTO	OFF ON	OFF ON	
Setting the gated sweep trigger	[:SENSE]:SWEep:GATE:SOURce	IMMediate IF EXT1 EXT2	IMM IF EXT1 EXT2	
Setting the trigger polarity of each trigger source	[:SENSE]:SWEep:GATE:SLOPe	NEGative POSitive	NEG POS	
Setting the trigger level of the EXT2 (external input terminal 2) trigger	[:SENSE]:SWEep:GATE:LEVel:EXtErnal	<real>	<real>	
Setting the trigger level of the IF trigger	[:SENSE]:SWEep:GATE:LEVel:IF	<real>	<real>	
Correction				
Switching the RF input level correction function ON and OFF	[:SENSE]:CORRection:CSET:STATe	OFF ON	OFF ON	
Entering the RF input level correction data	[:SENSE]:CORRection:CSET:DATA	<real1>,<real2>	--	*1
Deleting all the RF input level correction data	[:SENSE]:CORRection:CSET:DELEte	--	--	

*1 <real1> = Frequency data
 <real2> = Correction level data
 Delimited by a comma.

Function description	SCPI command	Parameter	Query reply	Remarks
Channel Power				
Executing the Auto Level Set function	[:SENSE]:CPOWer:POWeR:LEVel:AUTO	--	--	
Setting the measurement window display to ON or OFF	[:SENSE]:CPOWer:WINDow	OFF ON	OFF ON	
Specifying the measurement window display position	[:SENSE]:CPOWer:WINDow:POSition	<real>	<real>	
Specifying the measurement window display width	[:SENSE]:CPOWer:WINDow:WIDTh	<real>	<real>	
Setting the averaging calculation mode to ON or OFF	[:SENSE]:CPOWer:AVErAge[:STATe]	OFF ON	OFF ON	
Setting the number of times averaging is performed	[:SENSE]:CPOWer:AVErAge:COUNt	<int>	<int>	
Specifying the calculation type of the averaging calculation mode	[:SENSE]:CPOWer:AVErAge:MODE	CONTinuous REPeat	CONT REP	
Setting the upper limit value	[:SENSE]:CPOWer<screen>:LIMit:UPPer	<real>	<real>	
Setting the lower limit value	[:SENSE]:CPOWer<screen>:LIMit:LOWer	<real>	<real>	
Setting the judgment to ON or OFF	[:SENSE]:CPOWer:JUDGe	OFF ON	OFF ON	
Setting the standard values	[:SENSE]:CPOWer:SET:STANdard	--	--	
OBW				
Executing the Auto Level Set function	[:SENSE]:OBW:POWeR:LEVel:AUTO	--	--	
Specifying the OBW% value	[:SENSE]:OBW:PERCent	<real>	<real>	
Setting the number of times averaging	[:SENSE]:OBW:AVErAge:COUNt	<int>	<int>	
Setting the averaging calculation mode to ON or OFF	[:SENSE]:OBW:AVErAge[:STATe]	OFF ON	OFF ON	
Specifying the calculation type of the averaging calculation mode	[:SENSE]:OBW:AVErAge:MODE	CONTinuous REPeat	CONT REP	
Setting the upper limit value	[:SENSE]:OBW:LIMit:UPPer	<real>	<real>	
Setting the lower limit value	[:SENSE]:OBW:LIMit:LOWer	<real>	<real>	
Setting the judgment to ON or OFF	[:SENSE]:OBW:JUDGe	OFF ON	OFF ON	
Setting the standard values	[:SENSE]:OBW:SET:STANdard	--	--	

6.4.2 Subsystem-SENSE

Function description	SCPI command	Parameter	Query reply	Remarks
ACLR/ACP				
Executing the Auto Level Set function	[[:SENSE]:{ACLR ACP}:POWER:LEVEL:AUTO	--	--	
Copying the standard values	[[:SENSE]:{ACLR ACP}:DATA:COPY:STANDARD	--	--	
Setting the adjacent channel position and adjacent channel bandwidth	[[:SENSE]:{ACLR ACP}:CSBW:DATA	<real>,<real>,<real>	--	
Initializing the adjacent channel position and adjacent channel bandwidth data	[[:SENSE]:{ACLR ACP}:CSBW:DATA:DELETE	--	--	
Setting the Root Nyquist band calculation mode to ON or OFF	[[:SENSE]:{ACLR ACP}:RNYQUIST	OFF ON	OFF ON	
Setting the Symbol Rate value, which is used in the Root Nyquist band calculation mode	[[:SENSE]:{ACLR ACP}:RNYQUIST:SRATE	<real>	<real>	
Setting the filter coefficient, which is used in the Root Nyquist band calculation mode	[[:SENSE]:{ACLR ACP}:RNYQUIST:RFACtor	<real>	<real>	
Setting the number of times averaging is performed	[[:SENSE]:{ACLR ACP}:AVERAGE:COUNT	<int>	<int>	
Setting the averaging calculation mode to ON or OFF	[[:SENSE]:{ACLR ACP}:AVERAGE[:STATE]	OFF ON	OFF ON	
Specifying the calculation type of the averaging calculation mode	[[:SENSE]:{ACLR ACP}:AVERAGE:MODE	CONTinuous REPeat	CONT REP	
Setting the noise correction function to ON or OFF	[[:SENSE]:{ACLR ACP}:NCORrection[:STATE]	OFF ON	OFF ON	
Setting the judgment to ON or OFF	[[:SENSE]:{ACLR ACP}:JUDGE	OFF ON	OFF ON	
Setting the standard values	[[:SENSE]:{ACLR ACP}:SET:STANDARD	--	--	

Function description	SCPI command	Parameter	Query reply	Remarks
Multi Carrier ACLR/ACP				
Executing the Auto Level Set function	[:SENSE]:{MCAClr MCACp}:POWER:LEVEL:AUTO	--	--	
Setting the measurement carrier and adjacent channel to ON or OFF	[:SENSE]:{MCAClr MCACp}:PARAMeter {1 2 ... 16}:STATe	OFF ON	OFF ON	
Setting the offset frequency of the measurement carrier and adjacent channel	[:SENSE]:{MCAClr MCACp}:PARAMeter {1 2 ... 16}:FRFQuency	<real>	<real>	
Setting the channel bandwidth of the measurement carrier and adjacent channel area	[:SENSE]:{MCAClr MCACp}:PARAMeter {1 2 ... 16}:BWIDth	<real>	<real>	
Setting the reference power area of the measurement carrier and adjacent channel	[:SENSE]:{MCAClr MCACp}:PARAMeter {11 12 ... 16}:REFerence	<int>	<int>	
Setting a limit value, which is used to check measurement results as pass or fail	[:SENSE]:{MCAClr MCACp}:PARAMeter {11 12 ... 16}:LIMit	<real>	<real>	
Setting the Carrier Freq Adjustment function to ON or OFF	[:SENSE]:{MCAClr MCACp}:CARRier:ADJust :STATe	OFF ON	OFF ON	
Setting the Carrier Freq Adjustment value	[:SENSE]:{MCAClr MCACp}:CARRier:ADJust	<real>	<real>	
Setting the Root Nyquist filter calculation to ON or OFF	[:SENSE]:{MCAClr MCACp}:RNYQuist	OFF ON	OFF ON	
Setting the Symbol Rate value for Root Nyquist filter calculation	[:SENSE]:{MCAClr MCACp}:RNYQuist:SRATe	<real>	<real>	
Setting the filter coefficient, which is used in the Root Nyquist band calculation mode	[:SENSE]:{MCAClr MCACp}:RNYQuist:REACTor	<real>	<real>	
Setting the number of times averaging is performed	[:SENSE]:{MCAClr MCACp}:AVERAge:COUNT	<int>	<int>	
Setting the averaging calculation mode to ON or OFF	[:SENSE]:{MCAClr MCACp}:AVERAge[:STATe]	OFF ON	OFF ON	
Specifying the calculation type of the averaging calculation mode	[:SENSE]:{MCAClr MCACp}:AVERAge:MODE	CONTInuous REPeat	CONT REP	
Setting the noise correction function to ON or OFF	[:SENSE]:{MCAClr MCACp}:NCORrection [:STATe]	OFF ON	OFF ON	
Setting the judgment to ON or OFF	[:SENSE]:{MCAClr MCACp}:JUDGe	OFF ON	OFF ON	
Setting the standard values	[:SENSE]:{MCAClr MCACp}:SET:STANdard	--	--	

6.4.2 Subsystem-SENSE

Function description	SCPI command	Parameter	Query reply	Remarks
Spurious Emissions				
Executing the Auto Level Set function	[[:SENSE]:SPURious:POWer:LEVel:AUTO	--	--	
Creating the measurement table	[[:SENSE]:SPURious:DATA:CRFate	--	--	
Setting the First Carrier frequency	[[:SENSE]:SPURious:CARRier:FIRSt	<real>	<real>	
Setting the Last Carrier frequency	[[:SENSE]:SPURious:CARRier:LAST	<real>	<real>	
Registering the sweep parameters, which are used in the Spurious measurement, in the Spurious table	[[:SENSE]:SPURious:DATA[:NUMBer{1 2 3}]	<real1>,<real2>, <bool3>, <bool4>,<real4>, <bool5>,<real5>, <bool6>,<real6>, <real7>, <bool8>,<real8>, <bool9>, <real10>	--	*2
Selecting the Spurious table that is used	[[:SENSE]:SPURious:DATA[:NUMBer{1 2 3}] :ACTive	--	<int>	
Clearing all data registered in the Spurious table that is used	[[:SENSE]:SPURious:DATA[:NUMBer{1 2 3}] :DELete	--	--	
Setting the judgment to ON or OFF	[[:SENSE]:SPURious:JUDGE	OFF ON	OFF ON	
Setting the standard values	[[:SENSE]:SPURious:SET:STANdard	--	--	

*2 <real1> = Sweep start frequency (GHz/MHz/kHz/Hz)
 <real2> = Sweep stop frequency (GHz/MHz/kHz/Hz)
 <bool3> = { OFF | ON } Input Filter ON/OFF
 <bool4> = { OFF | ON } RBW AUTO/MANUAL
 <real4> = RBW (MHz/kHz/Hz)
 <bool5> = { OFF | ON } VBW AUTO/MANUAL
 <real5> = VBW (MHz/kHz/Hz)
 <bool6> = { OFF | ON } Sweep time AUTO/MANUAL
 <real6> = Sweep time (s/ms/μs)
 <real7> = Reference level (dBm)
 <bool8> = { OFF | ON } input ATT AUTO/MANUAL
 <real8> = Input attenuator (dB)
 <bool9> = { OFF | ON } Preamp ON/OFF
 <real10> = Spurious level judgment value (dBm)

Function description	SCPI command	Parameter	Query reply	Remarks
Spectrum Emission Mask				
Executing the Auto Level Set function	[:SENSE] :SEMAsk :POWer :LEVel :AUTO	--	--	
Setting the reference power calculation bandwidth	[:SENSE] :SEMAsk :CBWidth	<real>	<real>	
Setting the Root Nyquist filter calculation mode	[:SENSE] :SEMAsk :RNYQuist	OFF ON	OFF ON	
Setting the symbol rate, which is used for the Root Nyquist filter calculation	[:SENSE] :SEMAsk :RNYQuist :SRATe	<real>	<real>	
Setting the roll-off factor, which is used for the Root Nyquist filter calculation	[:SENSE] :SEMAsk :RNYQuist :RFACtor	<real>	<real>	
Setting the reference power calculation mode	[:SENSE] :SEMAsk :RPOWer :MODE	CHANnel PEAK	CHAN PEAK	
Setting the number of times averaging is performed	[:SENSE] :SEMAsk :AVERAge :COUNT	<int>	<int>	
Setting the averaging measurement function to ON or OFF	[:SENSE] :SEMAsk :AVERAge [:STATe]	OFF ON	OFF ON	
Setting the averaging mode of the averaging measurement function	[:SENSE] :SEMAsk :AVERAge :MODE	CONTInuous REPeat	CONT REP	
Setting the judgment to ON or OFF	[:SENSE] :SEMAsk :JUDGe	OFF ON	OFF ON	
Setting the standard values	[:SENSE] :SEMAsk :SET :STANdard	--	--	
Setting the measurement parameter table	[:SENSE] :SEMAsk :DATA	<real1>, <real2>,<real3>, <real4>,<real5>, <real6>,<real7>, <real8>,<type>	--	*3
Deleting all the measurement parameter tables	[:SENSE] :SEMAsk :DATA :DELEte	--	--	

*3
 <real1>= Offset Start frequency (GHz/MHz/kHz/Hz)
 <real2>= Offset Stop frequency (GHz/MHz/kHz/Hz)
 <real3>= integral bandwidth (ABS) (GHz/MHz/kHz/Hz)
 <real4>= absolute level judgment Start value (dBm)
 <real5>= absolute level judgment Stop value (dBm)
 <real6>= integral bandwidth (REL) (GHz/MHz/kHz/Hz)
 <real7>= relative level judgment Start value (dB)
 <real8>= relative level judgment Stop value (dB)
 <type>= { ABS | REL | AAR | AOR }

ABS: Judges only by using the absolute level judgment value
 REL: Judges only by using the relative level judgment value.
 AAR: Judges by using the AND condition of the absolute level value and the relative level judgment value.
 AOR: Judges by using the OR condition of the absolute level value and the relative level judgment value.

6.4.2 Subsystem-SENSE

Function description	SCPI command	Parameter	Query reply	Remarks
CCDF				
Executing the Auto Level Set function	[:SENSE]:CCDF:POWer:LEVel:AUTO	--	--	
Setting the resolution bandwidth (RBW)	[:SENSE]:CCDF:{BANDwidth BWIDth} [:RESolution]	<real>	<real>	
Setting the number of measurement samples	[:SENSE]:CCDF:POINt	<int>	<int>	
Setting the gate function to ON or OFF	[:SENSE]:CCDF:GAte	OFF ON	OFF ON	
Setting the threshold level of the gate function	[:SENSE]:CCDF:GAte:THReshold	<real>	<real>	
T-Domain Power				
Setting the averaging count	[:SENSE]:TDPower:AVERage:COUNt	<int>	<int>	
Setting the averaging calculation mode to ON or OFF	[:SENSE]:TDPower:AVERage[:STATe]	OFF ON	OFF ON	
Specifying the operation type in the averaging calculation mode	[:SENSE]:TDPower:AVERage:MODE	CONTinuous REPeat	CONT REP	
Executing the Auto Level Set function	[:SENSE]:TDPower:POWer:LEVel:AUTO	--	--	
Setting the measurement window display to ON or OFF	[:SENSE]:TDPower:WINDow	OFF ON	OFF ON	
Specifying the measurement window display position	[:SENSE]:TDPower:WINDow:POStion	<real>	<real>	Time
Specifying the measurement window display width	[:SENSE]:TDPower:WINDow:WIDTh	<real>	<real>	Time
Setting the Upper limit	[:SENSE]:TDPower:LIMit:UPPer	<real>	<real>	Level
Setting the Lower limit	[:SENSE]:TDPower:LIMit:LOWer	<real>	<real>	Level
Setting the judgment to ON or OFF	[:SENSE]:TDPower:JUDGe	OFF ON	OFF ON	
Setting the Standard values	[:SENSE]:TDPower:SET:STANdard	--	--	
ON/OFF Ratio				
Setting the averaging count	[:SENSE]:OORatio:AVERage:COUNt	<int>	<int>	
Setting the averaging calculation mode to ON or OFF	[:SENSE]:OORatio:AVERage[:STATe]	OFF ON	OFF ON	
Specifying the operation type in the averaging calculation mode	[:SENSE]:OORatio:AVERage:MODE	CONTinuous REPeat	CONT REP	
Executing the Auto Level Set function	[:SENSE]:OORatio:POWer:LEVel:AUTO	--	--	
Setting the display position of the ON window	[:SENSE]:OORatio:WINDow:ON:POStion	<real>	<real>	Time
Setting the display width of the ON window	[:SENSE]:OORatio:WINDow:ON:WIDTh	<real>	<real>	Time

6.4.3 Subsystem-CONFigure

Function description	SCPI command	Parameter	Query reply	Remarks
Setting the display position of the OFF window	[:SENSe]:OORatio:WINDow:OFF:POSItion	<real>	<real>	Time
Setting the display width of the OFF window	[:SENSe]:OORatio:WINDow:OFF:WIDTh	<real>	<real>	Time
Setting the limit	[:SENSe]:OORatio:LIMit	<real>	<real>	
Setting the judgment to ON or OFF	[:SENSe]:OORatio:JUDGe	OFF ON	OFF ON	
Setting the Standard values	[:SENSe]:OORatio:SHt:STANdard	--	--	

6.4.3 Subsystem-CONFigure

Function description	SCPI command	Parameter	Query reply	Remarks
Entering the Channel Power measurement mode	:CONFigure:CPOWer	--	--	
Entering the OBW measurement mode	:CONFigure:OBW	--	--	
Entering the Multi-Carrier ACLR/ACP measurement mode	:CONFigure:{MCAClR MCACp}	--	--	
Entering the ACLR/ACP measurement mode	:CONFigure:{AClR ACP}	--	--	
Entering the Spurious measurement mode	:CONFigure:SPURious	--	--	
Entering the Spectrum Emission Mask measurement mode	:CONFigure:SEMask	--	--	
Entering the CCDF measurement mode	:CONFigure:CCDF	--	--	
Entering the T-Domain Power measurement mode	:CONFigure:TDPower	--	--	
Entering the ON/OFF Ratio measurement mode	:CONFigure:OORatio	--	--	

6.4.4 Subsystem-MEASure/READ/FETCH

6.4.4 Subsystem-MEASure/READ/FETCH

MEMO: *The reply formats of the Measure, Read, and Fetch commands are the same. The difference between the Measure and Read commands and Fetch command is that the Measure and Read commands are used to execute measurements and the Fetch command is used to read result data. Both the Measure and Read commands execute measurements. However, the initialization processes for the commands that are made when entering the measurement mode are different. The differences are described in the function description given later. If no descriptions are given, the initialization processes are the same. If the Fetch command is issued without entering the corresponding measurement mode, a Query error occurs.*

Function description	SCPI command	Parameter	Query reply	Remarks
Channel Power				
Performing the Channel Power measurement and reading the measurement result (Trace)	:MEASure:CPOWer?	--	<real>	
Performing the Channel Power measurement and reading the average power density (Trace)	:MEASure:CPOWer:PDENsity?	--	<real>	
Performing the Channel Power measurement and reading the measurement result (RMS)	:MEASure:CPOWer:RMS?	--	<real>	
Performing the Channel Power measurement and reading the average power density (RMS)	:MEASure:CPOWer:RMS:PDENsity?	--	<real>	
Performing the Channel Power measurement and reading the total Pass/Fail judgment	:MEASure:CPOWer:FAIL?	--	PASS FAIL	
OBW				
Performing the OBW measurement and reading all measurement results	:MEASure:OBW?	--	<real>,<real>	
Performing the OBW measurement and reading the measurement result (only the OBW value)	:MEASure:OBW:OBW?	--	<real>	
Performing the OBW measurement and reading the measurement result (only the OBW center frequency)	:MEASure:OBW:FCENter?	--	<real>	
Performing the OBW measurement and reading the total Pass/Fail judgment	:MEASure:OBW:FAIL?	--	PASS FAIL	

6.4.4 Subsystem-MEASure/READ/FETCH

Function description	SCPI command	Parameter	Query reply	Remarks
Performing the ACLR/ACP measurement and reading all measurement results	:MEASure:{ACLR ACP}:NUMBer{1 2 3 4 5} ?	--	<real1>,<real2>,<real3>[. ...]	*1
Performing the ACLR/ACP measurement and reading the results of reference power measurement	:MEASure:{ACLR ACP}:RPOWer?	--	<real>	
Performing the ACLR/ACP measurement and reading all measurement results of the specified channels on the Upper side	:MEASure:{ACLR ACP}:UPPer[:NUMBer{1 2 3 4 5}]?	--	<real1>[. ...]	*2
Performing the ACLR/ACP measurement and reading all measurement results of the specified channels on the Lower side	:MEASure:{ACLR ACP}:LOWer[:NUMBer{1 2 3 4 5}]?	--	<real1>[. ...]	*2
Performing the ACLR/ACP measurement and reading the total Pass/Fail judgment	:MEASure:{ACLR ACP}:FAIL?	--	PASS FAIL	

*1 When the NUMBER header is omitted:<real1>,<real2>,<real3>[.]
 <real1> = Real value that indicates the reference power. Unit: dBm,
 <real2> = Real value that indicates the lower level(1). Unit: dB,
 <real3> = Real value that indicates the upper level(1). Unit: dB,
 <real4> = Real value that indicates the lower level(2). Unit: dB,
 <real5> = Real value that indicates the upper level(2). Unit: dB,

 <real2n>= Real value that indicates the lower level(n). Unit: dB,
 <real2n+1>= Real value that indicates the upper level(n). Unit: dB

n: Number of channels measured in the ACP measurement (up to 5 groups)

When the NUMBER header is specified:<real1>,<real2>,<real3>
 <real1> = Real value that indicates the reference power. Unit: dBm,
 <real2> = Real value that indicates the lower level(m). Unit: dB,
 <real3> = Real value that indicates the upper level(m). Unit: dB
 m: The number that indicates the specified adjacent channel

*2 When the NUMBER header is omitted:<real1>[. ...], <real2>, ..., <realn>[. ...] (Real value that indicates the Upper/Lower channel. Unit: dB)
 <real1> = Real value that indicates the upper/lower level(1). Unit: dB,
 <real2> = Real value that indicates the upper/lower level(2). Unit: dB,

 <realn> = Real value that indicates the upper/lower level(n). Unit: dB

n: Number of channels measured in the ACP measurement (up to 5 groups)

When the NUMBER header is specified:<real> (Real value that indicates the Upper/Lower Channel level{1|2|3|4|5}. Unit: dB)
 <real1> = Real value that indicates the upper/lower level(m). Unit: dB
 m: The number that indicates the specified adjacent channel

6.4.4 Subsystem-MEASure/READ/FETCh

Function description	SCPI command	Parameter	Query reply	Remarks
Performing the Multi-Carrier ACLR/ACP measurement and reading the measurement result	:MEASure:{MCAClr MCACp} [:NUMBer{1 2 3 4 5 6}]?	--	<real1>,<real2>, <int1>[, ...]	*3
Performing the Multi-Carrier ACLR/ACP measurement and reading the carrier power values	:MEASure:{MCAClr MCACp}:CPOWer [:NUMBer{1 2 ... 9 10}]?	--	<real>,<real>...	*4
Performing the Multi-Carrier ACLR/ACP measurement and reading the total Pass/Fail judgment	:MEASure:{MCAClr MCACp}:FAIL?	--	PASS FAIL	

*3 When the NUMBer header is omitted:<real1>,<real2>,<int1>[,<real>,<real>,<int>]. ... [<real>,<real>,<int>]

<real1> = Reference power(1):Unit: dBm,
<real2> = ACP level(1):Unit: dB,
<int1> = Pass/Fail(1): 0/1,

[<real> = Reference power(2);
<real> = ACP level(2) ,
<int> = Pass/Fail(2)].

.....
[<real> = Reference power(n),
<real> = ACP level(n),
<int> = Pass/Fail(n)]]

n: Number of channels measured in the multi-carrier power measurement (up to 6 groups)

When the NUMBer header is specified:<real1>,<real2>,<int1>

<real1> = Reference power(m):Unit: dBm,
<real2> = ACP level(m):Unit: dB,
<int1> = Pass/Fail(m): 0/1,

m: Specified adjacent channel number

*4 When specified by the NUMBer header:<real1> [, <real>, <real>, <real>, <real>, <real>]
(All real values that indicates the Carrier Power. Unit: dBm)

<real1> = Carrier Power(1): Unit: dBm,
| <real> = Carrier Power(2): Unit: dBm
:
<real> = Carrier Power(n): Unit: dBm]

n: Number of carrier signals set before the measurement (up to 10)

When specified by the NUMBer header:<real>(Real value that indicates the Carrier Power value. Unit: dBm)

<real> = Carrier Power(m): Unit: dBm

m: Specified carrier number

Function description	SCPI command	Parameter	Query reply	Remarks
Spurious Emissions Performing the Spurious measurement and reading all measurement results	:MEASure:SPURious[:NUMBER{1 2... 14 15}]?	--	<real1>,<real2>, <int>[,...]	*5
Performing the Spurious measurement and reading the total Pass/Fail judgment	:MEASure:SPURious:FAIL?	--	PASS FAIL	

*5 When the NUMBER header is omitted:<real1>,<real2>,<int>|,<real>,<real>,<int>|, ...,|<real>,<real>,<int>|

<real1> = Freq(11): Unit: Hz
 <real2> =Level(11): Unit: dBm,
 <int> = P/F(11):0/1,

[[<real> = Freq(12), <real> = Level(12), <int> = P/F(12)],

 [<real> = Freq(nm), <real> =Level(nm), <int> = P/F(nm)]]

n: Measurement area number in the Spurious table: Highest 15
 m: Number of data items detected as spurious in one measurement area: Up to 10

n depends on the number of measurement areas in the set Spurious table
 m depends on the number of spurious signals detected in the measurement area

When the NUMBER header is specified:<real1>,<real2>,<int>[,<real>,<real>,<int>], ...,|<real>,<real>,<int>]]

<real1> = Freq(n1): Unit: Hz
 <real2> =Level(n1): Unit: dBm,
 <int> = P/F(n1):0/1,

[[<real> = Freq(n2), <real> = Level(n2), <int> = P/F(n2)],

 [<real> = Freq(nm), <real> =Level(nm), <int> = P/F(nm)]]

n: Measurement area number in the Spurious table: Can be set from 1 to 15
 m: Number of data items detected as spurious: Up to 10

6.4.4 Subsystem-MEASure/READ/FETCH

Function description	SCPI command	Parameter	Query reply	Remarks
Performing the Spectrum Emission Mask measurement and reading the results	:MEASure:SEMask[:NUMBER{1 2 3 4 5}]?	--	<real1>,<real2>,<real3>,<int1>,<real4>,<real5>,<real6>,<int4>	*6
Performing the Spectrum Emission Mask measurement and reading the reference power results	:MEASure:SEMask:RPOWER?	--	<real>	
Performing the Spectrum Emission Mask measurement and reading the total Pass/Fail judgment	:MEASure:SEMask:FAIL?	--	PASS FAIL	

*6 When the NUMBER header is omitted:
 <real1>,<real2>,<real3>,<int1>,<real4>,<real5>,<real6>,<int4>, [<real>,<real>,<real>,<int>,<real>,<real>,<real>,<int>],
], [<real>,<real>,<real>,<int>,<real>,<real>,<real>,<int>]]

<real1> = Upper freq(1): Unit: Hz,
 <real2> = Upper Level Abs(1): Unit: dBm,
 <real3> = Upper Level Rel(1): Unit: dB,
 <int1> = Upper P/F(1): 0/1,
 <real4> = Lower freq(1): Unit: Hz,
 <real5> = Lower Level Abs(1): Unit: dBm,
 <real6> = Lower Level Rel(1): Unit: dB,
 <int4> = Lower P/F(1) : 0/1,

[<real> = Upper freq(2), <real> = Upper Level Abs(2), <real> = Upper Level Rel(2), <int> =Upper P/F(2),],

....
 [<real> = Upper Freq(n), <real> = Upper Level Abs(n), <real> = Upper Level Rel(n),
 <int> = Upper P/F(n), <real> = Lower Freq(n), <real> = Lower level Abs(n),
 <real> = Lower Level Rel(n), <int> = Lower P/F(n)]

n: Number of measurement areas that are defined: Up to 5

When the NUMBER header is specified

<real1>,<real2>,<real3>,<int1>,<real4>,<real5>,<real6>,<int4>

<real1> = Upper freq(n): Unit: Hz,
 <real2> = Upper Level Abs(n): Unit: dBm,
 <real3> = Upper Level Rel(n): Unit: dB,
 <int1> = Upper P/F(n): 0/1,
 <real4> = Lower freq(n): Unit: Hz,
 <real5> = Lower Level Abs(n): Unit: dBm,
 <real6> = Lower Level Rel(n): Unit: dB,
 <int4> = Lower P/F(n) : 0/1

n: Defined measurement areas 1 to 5

6.4.4 Subsystem-MEASure/READ/FETCH

Function description	SCPI command	Parameter	Query reply	Remarks
Performing the CCDF measurement and reading the measurement result	:MEASure:CCDF[:NUMBer{1 2 3 4 5 6}]?	--	<real1>,<real2>,<real3>,<real4>,<real5>,<real6>,<real7>,<real8>	*7
Performing the CCDF measurement and reading Peak Factor	:MEASure:CCDF:PFACtor?	--	<real>	
Performing the CCDF measurement and reading Average Power	:MEASure:CCDF:APOWer?	--	<real>	
Performing the CCDF measurement and reading the power ratio	:MEASure:CCDF:PRATio[:NUMBer{1 2 3 4 5 6}]?	--	<real1>,<real2>,<real3>,<real4>,<real5>,<real6>	*8

*7 When the NUMBer header is omitted:
 <real1>, <real2>, <real3>, <real4>, <real5>, <real6>, <real7>, <real8>

<real1> = Peak Factor: Unit: dB,
 <real2> = Average Power: Unit: dBm,
 <real3> = Power ratio of 10.0%: Unit: dB,
 <real4> = Power ratio of 1.0%: Unit: dB,
 <real5> = Power ratio of 0.1%: Unit: dB,
 <real6> = Power ratio of 0.01%: Unit: dB,
 <real7> = Power ratio of 0.001%: Unit: dB,
 <real8> = Power ratio of 0.0001%: Unit: dB,

When the NUMBer header is specified:
 <real1>, <real2>, <real3>,

<real1> = Peak Factor: Unit: dB,
 <real2> = Average Power: Unit: dBm,
 <real3> = Power ratio specified: Unit: dB,

*8 When the NUMBer header is omitted:
 <real1>, <real2>, <real3>, <real4>, <real5>, <real6>

<real1> = Power ratio of 10.0%: Unit: dB,
 <real2> = Power ratio of 1.0%: Unit: dB,
 <real3> = Power ratio of 0.1%: Unit: dB,
 <real4> = Power ratio of 0.01%: Unit: dB,
 <real5> = Power ratio of 0.001%: Unit: dB,
 <real6> = Power ratio of 0.0001%: Unit: dB,

When the NUMBer header is specified:
 <real> = Power ratio specified: Unit: dB

6.4.4 Subsystem-MEASure/READ/FETCh

Function description	SCPI command	Parameter	Query reply	Remarks
T-Domain Power Executing the T-Domain Power measurement and reading the result	:MEASure:TDPower?	--	<real>,<int>	*9
Executing the T-Domain Power measurement and reading the Pass/Fail judgment to the template	:MEASure:TDPower:TEMPlate:FAIL?	--	PASS FAIL	
Executing the T-Domain Power measurement and reading the total Pass/Fail judgment	:MEASure:TDPower:FAIL?	--	PASS FAIL	
ON/OFF Ratio Executing the ON/OFF Ratio measurement and reading the result	:MEASure:OORatio?	--	<real1>,<real2>,<real3>,<int>	*10
Executing the ON/OFF Ratio measurement and reading the total Pass/Fail judgment	:MEASure:OORatio:FAIL?	--	PASS FAIL	

*9 <real1> = Power: Unit dBm,
<int> = Judgment (Pass=0/Fail=1)

*10 <real1> = Power in the ON period: Unit dBm,
<real2> = Power in the OFF period: Unit dBm,
<real3> = Power ratio of the ON period to the OFF period: Unit dB,
(Power in the ON period / Power in the OFF period)
<int> = Judgment (Pass=0/Fail=1)

6.4.5 Subsystem-INITiate

Function description	SCPI command	Parameter	Query reply	Remarks
Continuous sweep mode to ON or OFF	:INITiate:CONTinuous	OFF ON	OFF ON	
Starting a sweep or measurement	:INITiate:IMMEDIATE	--	--	
Resetting and restarting a sweep	:INITiate:RHS'tart	--	--	
Stopping a sweep	:INITiate:ABORt	--	--	
Resetting and restarting a sweep, and suspending after the completion of the sweep	:INITiate:TS	--	--	

6.4.6 Subsystem-TRIGger

Function description	SCPI command	Parameter	Query reply	Remarks
TRIGger				
Setting the trigger	:TRIGger[:SEQuence]:SOURce	IMMEDIATE IF VIDeo EXT1 EXT2	IMM IF EXT1 VID EXT2	*1
Setting the trigger polarity of each trigger source	:TRIGger[:SEQuence]:SLOPe	NEGative POSitive	NEG POS	
Setting the trigger level for video trigger	:TRIGger[:SEQuence]:LEVel:VIDeo	<real>	<real>	
Setting the trigger level for an EXT2 (external input terminal 2) trigger	:TRIGger[:SEQuence]:LEVel:EXTernal	<real>	<real>	
Setting the trigger level for an IF trigger	:TRIGger[:SEQuence]:LEVel:IF	<real>	<real>	
Setting a trigger delay value	:TRIGger[:SEQuence]:DELay	<real>	<real>	

- *1 IMMEDIATE: Free-run mode without trigger setting
 IF: IF trigger
 EXT1: EXT1 input signal trigger
 EXT2: EXT2 input signal trigger

6.4.7 Subsystem-DISPlay

6.4.7 Subsystem-DISPlay

Function description	SCPI command	Parameter	Query reply	Remarks
Setting the reference level	:DISPlay:TRACe:Y[:SCALe]:RLEVel	<real>	<real>	
Setting the offset value to the reference level value	:DISPlay:TRACe:Y[:SCALe]:RLEVel:OFFSet	<real>	<real>	
Setting the offset value to the reference level value to ON or OFF	:DISPlay:TRACe:Y[:SCALe]:RLEVel:OFFSet:STATe	OFF ON	OFF ON	
Setting the scale per division on a log display	:DISPlay:TRACe:Y[:SCALe]:PDIVision	<real>	<real>	
Setting the display mode of the specified trace	:DISPlay:TRACe:MODE	WRITE MAXHold AVERAge	WRITE MAXH AVER	
Setting the reference waveform display in the CCDF measurement to ON or OFF	:DISPlay:TRACe:CCDF:STATe	OFF ON	OFF ON	
Setting the ideal Gaussian noise waveform display to ON or OFF	:DISPlay:TRACe:CCDF:GAUSSian:STATe	OFF ON	OFF ON	
Setting the maximum horizontal axis value of the waveform display	:DISPlay:TRACe:X[:SCALe]:CCDF	<real>	<real>	

6.4.8 Subsystem-MMEMory

Function description	SCPI command	Parameter	Query reply	Remarks
Specifying the device used when executing the SAVE and LOAD functions.	:MMEMory:DEvice	C D E	C D E	*1
Saving the settings of this instrument	:MMEMory:STORe:STATe	<int>	-	*2
Loading the settings of this instrument	:MMEMory:LOAD:STATe	<int>		*2
Saving the TxTester measurement conditions	:MMEMory:SElect:ITEM:TXTester:SETup	OFF ON	OFF ON	

*1 The following devices are specified depending on the parameter:

- C C:\MyData\SVRCL
- D D:\ADVANTEST
- E E:\ADVANTEST

*2: A number, which is a maximum of 4-digit and is added to the file name of the data to be saved or loaded, must be specified in <int>.

6.4.9 Subsystem-CALCulate

MEMO: *The following notations are used only in the Calculate subsystem.*

<mkr>: *Written in the command header and indicates the active marker number of the command. The marker number ranges from 1 to 10. The number can also be specified by {1/2/3/4/5/6/7/8/9/10}.*

<area>: *Written in the command header and indicates the active area number of the command. The area number ranges from 1 to 10. The number can also be specified by {1/2/3/4/5/6/7/8/9/10}.*

Function description	SCPI command	Parameter	Query reply	Remarks
Specifying an operation target marker (active marker) among the multi-markers	:CALCulate:MARKer[:NUMBer<mkr>]:ACTive	--	<int>	
Setting the marker functions to ON or OFF	:CALCulate:MARKer:FUNCTion[:STATe]	OFF ON	OFF ON	
Setting the specified multi-marker to ON or OFF	:CALCulate:MARKer[:NUMBer<mkr>][:STATe]	OFF ON	OFF ON	
Specifying a frequency position and a time position of the specified multi-marker	:CALCulate:MARKer[:NUMBer<mkr>]:X	<real>	<real>	
Reading the absolute values (frequency and time) of the specified multi-marker	:CALCulate:MARKer[:NUMBer<mkr>]:X:ABSolute?	--	<real>	
Reading the absolute level value of the specified multi-marker	:CALCulate:MARKer[:NUMBer<mkr>]:Y:ABSolute?	--	<real>	
Reading the level value of the specified multi-marker	:CALCulate:MARKer[:NUMBer<mkr>]:Y?	--	<real>	
Searching for the maximum peak point by using the specified multi-marker	:CALCulate:MARKer[:NUMBer<mkr>]:MAXimum[:PEAK]	--	--	
Searching for the next peak by using the specified multi-marker	:CALCulate:MARKer[:NUMBer<mkr>]:MAXimum:NEXT	--	--	
Searching for the next peak in the left direction by using the specified multi-marker	:CALCulate:MARKer[:NUMBer<mkr>]:MAXimum:LEFT	--	--	
Searching for the next peak in the right direction by using the specified multi-marker	:CALCulate:MARKer[:NUMBer<mkr>]:MAXimum:RIGHT	--	--	
Searching for the minimum peak by using the specified multi-marker	:CALCulate:MARKer[:NUMBer<mkr>]:MINimum[:PEAK]	--	--	
Searching for the next minimum peak by using the specified multi-marker	:CALCulate:MARKer[:NUMBer<mkr>]:MINimum:NEXT	--	--	
Setting the specified marker to the specified trace	:CALCulate:MARKer[:NUMBer<mkr>]:TRACe	<int>	<int>	

6.4.9 Subsystem-CALCulate

Function description	SCPI command	Parameter	Query reply	Remarks
Setting all markers excluding marker No. 1 to OFF	:CALCulate:MARKer:RfSet	--	--	
Displaying the marker list of the displayed markers	:CALCulate:MARKer:LIST[:STATe]	OFF ON	OFF ON	
Specifying a deviation for peak point judgment at the time of peak point search	:CALCulate:MARKer:MAXimum:DElTa	<real>	<real>	
Setting the marker step size	:CALCulate:MARKer:STEP	<real>	<real>	
Setting the marker step size mode	:CALCulate:MARKer:STEP:AUTO	OFF ON	OFF ON	
Setting a peak search range specification mode on the horizontal axis	:CALCulate:MARKer:SEARch:X:MODE	ALL INNER OUTer	ALL INN OUT	
Specifying the reference position of the peak search range on the horizontal axis	:CALCulate:MARKer:SEARch:X:POSition	<real>	<real>	
Specifying a search width from the reference position of the peak search range on the horizontal axis	:CALCulate:MARKer:SEARch:X:WIDTh	<real>	<real>	
Setting an coupling mode of the peak search range on the horizontal axis	:CALCulate:MARKer:SEARch:X:COUPling	OFF ON	OFF ON	
Setting a peak search range specification mode on the vertical axis	:CALCulate:MARKer:SEARch:Y:MODE	ALL DI.LINe LLINe	ALL DI.LIN LLIN	
Specifying the peak search range with Display Line used as the reference	:CALCulate:MARKer:SEARch:Y:DI.LINe	ABOVe BELow	ABOV BEL	
Specifying the peak search range with Limit Line1 used as the reference	:CALCulate:MARKer:SEARch:Y:LUPPer	ABOVe BELow	ABOV BEL	
Specifying the peak search range with Limit Line2 used as the reference	:CALCulate:MARKer:SEARch:Y:LLOWer	ABOVe BELow	ABOV BEL	
Setting the marker frequency as the center frequency	:CALCulate:MARKer[:NUMBer<mkr>]:SET:CENTer	--	--	
Setting the marker level value as the reference level	:CALCulate:MARKer[:NUMBer<mkr>]:SET:RLEVel	--	--	
Setting the marker frequency as the center frequency step size	:CALCulate:MARKer[:NUMBer<mkr>]:SET:CENTer:STEP	--	--	
Setting the marker frequency as the marker step size	:CALCulate:MARKer[:NUMBer<mkr>]:SET:MARKer:STEP	--	--	
Setting the marker frequency as the center frequency after the peak search is performed	:CALCulate:MARKer[:NUMBer<mkr>]:MAXimum:SET:CENTer	--	--	

Function description	SCPI command	Parameter	Query reply	Remarks
Setting the marker level value as the reference level after the peak search is performed	:CALCulate:MARKer[:NUMBer<mkr>]:MAXimum:SET:RLEVEl	--	--	
Setting the Δ marker \rightarrow center frequency	:CALCulate:DELTamarker[:NUMBer<mkr>]:MAXimum:SET:CENTer	--	--	
Setting the Δ marker \rightarrow span frequency	:CALCulate:DELTamarker[:NUMBer<mkr>]:MAXimum:SET:SPAN	--	--	
Setting the Δ marker \rightarrow center frequency step size	:CALCulate:DELTamarker[:NUMBer<mkr>]:MAXimum:SET:CENTer:STEP	--	--	
Setting the Δ marker \rightarrow marker step size	:CALCulate:DELTamarker[:NUMBer<mkr>]:MAXimum:SET:MARKer:STEP	--	--	
Setting the Δ marker display to ON or OFF	:CALCulate:DELTamarker[:STATE]	OFF ON	OFF ON	
Setting the fixed Δ marker display to ON or OFF	:CALCulate:DELTamarker:FIXed[:STATE]	OFF ON	OFF ON	
Setting the fixed marker after the peak is searched	:CALCulate:DELTamarker:FIXed:MAXimum[:PEAK]	--	--	
Setting the (1/ Δ) marker display to ON or OFF	:CALCulate:DELTamarker:INVerse[:STATE]	OFF ON	OFF ON	
Reading the Δ marker frequency	:CALCulate:DELTamarker:X?	--	<real>	
Reading the level value of the Δ marker	:CALCulate:DELTamarker:Y?	--	<real>	
Specifying a reference for displaying marker in relative values	:CALCulate:MARKer:ROBject	DELTamarker ANCHor LIM1 LIM2 DLINE RLINE TRA1 TRA2 TRA3 TRA4 OSCRen NREFERENCE	DELT ANCH LIM1 LIM2 DLINE RLINE TRA1 TRA2 TRA3 TRA4 OSCR NREF	
T-Domain Power				
Setting the template to ON or OFF	:CALCulate:TDPower:TEMPlate[:STATE]	OFF ON	OFF ON	
Setting the moving distance of the template on the horizontal axis	:CALCulate:TDPower:TEMPlate:SHIFt:X	<real>	<real>	Time
Setting the moving distance of the template on the vertical axis	:CALCulate:TDPower:TEMPlate:SHIFt:Y	<real>	<real>	Level
Adding the upper data of the template	:CALCulate:TDPower:TEMPlate:UPPer:DATA	<real1>,<real2>	--	Time, Level
Adding the lower data of the template	:CALCulate:TDPower:TEMPlate:LOWer:DATA	<real1>,<real2>	--	Time, Level
Deleting the upper data of the template	:CALCulate:TDPower:TEMPlate:UPPer:DELeTe	--	--	
Deleting the lower data of the template	:CALCulate:TDPower:TEMPlate:LOWer:DELeTe	--	--	

6.4.10 Subsystem-SYSTEM

Function description	SCPI command	Parameter	Query reply	Remarks
Setting the coupling mode of the template with power to ON or OFF	:CALCulate:TDPower:TEMPlate:COUPlE	OFF ON	OFF ON	
Setting the limit of the template	:CALCulate:TDPower:TEMPlate:LIMit	<real>	<real>	Level

6.4.10 Subsystem-SYSTEM

Function description	SCPI command	Parameter	Query reply	Remarks
Initializing each measurement system parameter	:SYSTem:PRESet	--	--	
Initializing all measurement systems	:SYSTem:PRESet:ALL	--	--	
Selecting a measurement system	:SYSTem:SELect	SANalyzer TXTester	SAN TXT	
Inquiring about the most recent error	:SYSTem:ERRor?	--	<int>,<str>	*1
Inquiring about the error log	:SYSTem:ERRor:ALL?	--	<int>,<str>	*1
Inquiring about the R3477 series options	:SYSTem:OPTions?	--	<str>[,...]	

*1 Returns an error number to <int> and an error message string to <str>.

6.4.11 Subsystem-STATUS

Function description	SCPI command	Parameter	Query reply	Remarks
Setting the standard operation enable register	:STATus:OPERation:ENABLE	<int>	<int>	
Reading the standard operation event register	:STATus:OPERation:EVENT?	--	<int>	
Setting the questionable enable register	:STATus:QUEStionable:ENABLE	<int>	<int>	
Reading the questionable event register	:STATus:QUEStionable:EVENT?	--	<int>	
Setting the measuring enable register	:STATus:OPERation:MEASure:ENABLE	<int>	<int>	
Reading the measuring event register	:STATus:OPERation:MEASure:EVENT?	--	<int>	

6.5 Status Register

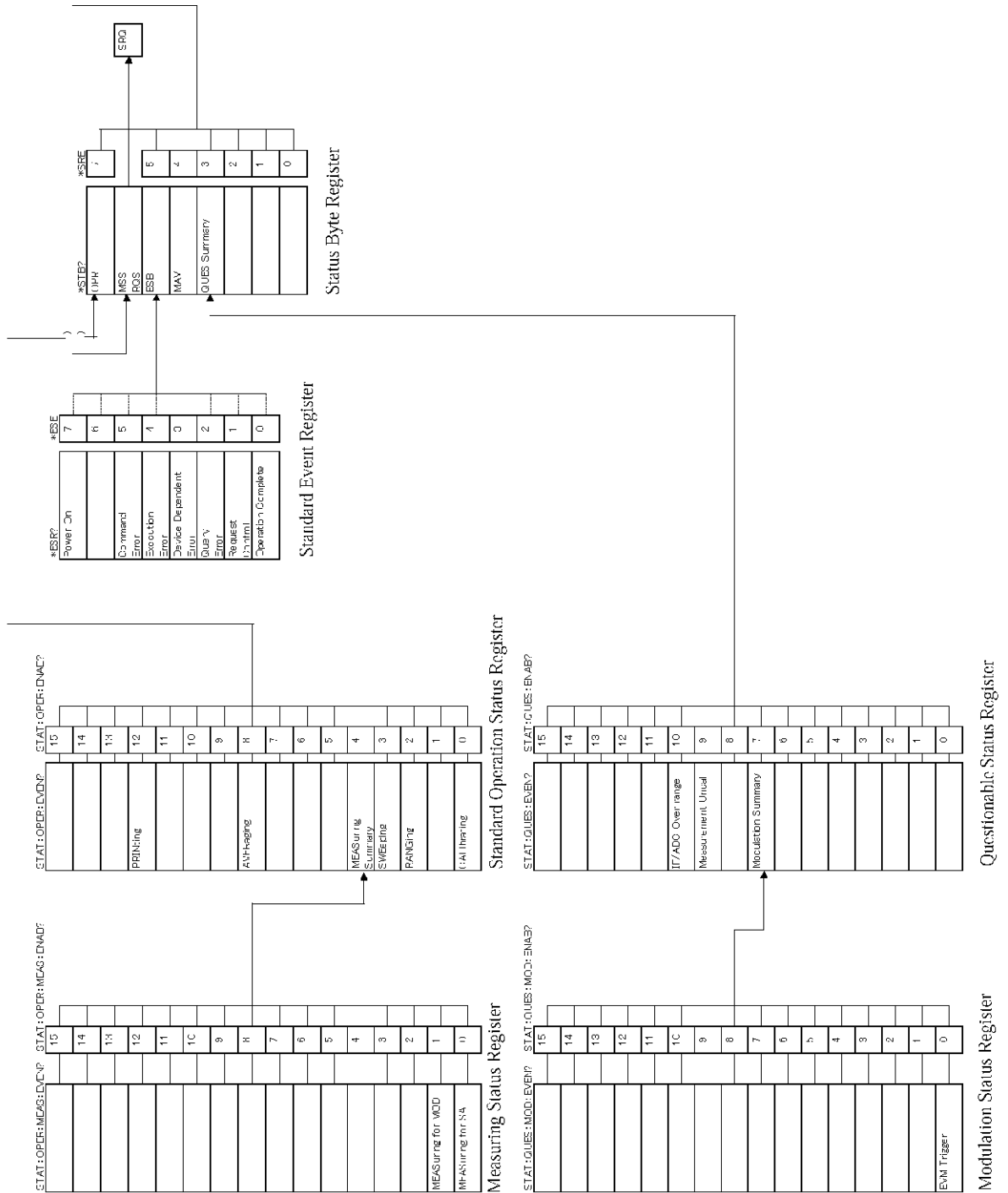

Figure 6-1 Status Registers

7. PERFORMANCE VERIFICATION

This chapter describes how to verify whether this instrument meets the specified performance.

Test data record sheets are included on the last few pages of this chapter. It is recommended that data from the performance test is kept as a record by using a copy of these sheets.

IMPORTANT: *Before executing the performance verification, perform the warm-up procedure and all calibration procedures.*

7.1 Test Signal Specifications

The following list shows the test signals that are used for the performance verification.

Table 7-1 List of Test Signal Specifications

No.	Test signal name	Signal specifications	Test item
1	WiBro 16e downlink signal	Center frequency: 2.35 GHz Power: -10 dBm The number of data symbols: 25 Cell ID: 1 Sector ID: 0 Data subcarrier modulation format: QPSK	Power measurement Center frequency error measurement

7.2 Test Procedures

7.2 Test Procedures

Connect the signal source as follows.

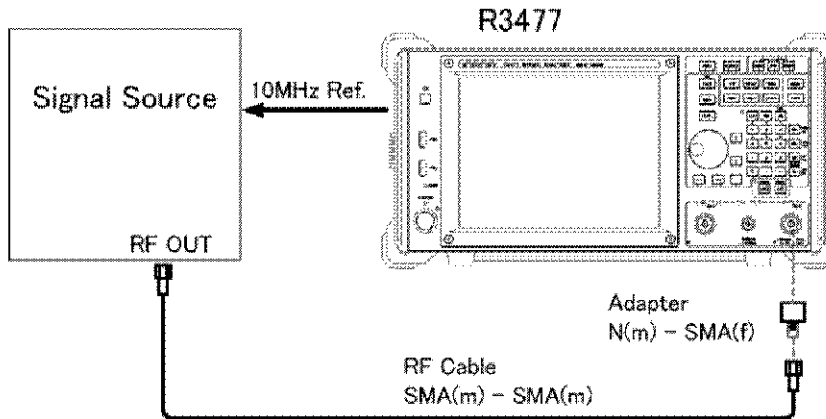

Figure 7-1 Connection Diagram of Signal Source

1. Press the **CONFIG** key and touch the **STD Setup** key. The **[STD Setup]** dialog box is displayed on the screen. Set **[Type]** to **[WiBro16e_DL]** and touch the **Apply** key.
2. Press **SHIFT** and **LCL** (PRESET). All items are returned to their default values.
3. Press **FREQ**, **Center**, **2**, **.**, **3**, **5**, and **GHz**.
4. Press **FUNC**, **Modulation**, and **Auto Level Set**, and execute Auto Level Set.
5. Press **SINGLE** to perform the measurement.
6. Enter Power [dBm] and Freq. Error [Hz] in Total Result into the test data record sheet.

7.3 Test Data Record Sheets

Test data record sheets

Model name:

Serial number:

Test signal	Test item	Specifications			Judgment Pass/Fail
		Minimum value	Measured value	Maximum value	
WiBro 16e downlink signal	Power measurement (@2.35 GHz)	-10.9 dBm		-9.1 dBm	
	Center frequency error measurement	-10 Hz		+10 Hz	

8. SPECIFICATIONS

8.1 WiBro 16e Modulation Analysis Performance

Item	Specifications
Temperature range	+20°C - +30°C
Input frequency range RF input	20 MHz - 3.3 GHz
Input level range RF input	Preamp OFF -20 dBm - +30 dBm
Constellation error measurement Residual constellation error	After Auto Level Set is executed for the WiBro downlink signal, RMS value on 25 symbol with CH Estimation(Preamble). < -40 dB
Power measurement Measurement accuracy Frequency response 50 MHz - 2.5 GHz 20 MHz - 3.3 GHz Calibration signal level accuracy Measurement accuracy (typ.)	After Auto Level Set is executed for the WiBro downlink signal of -10 dBm, Averaged Power on 25 symbol with CH Estimation(Preamble). < ± (0.3 + Frequency Response + Calibration Signal Level Accuracy) dB < ±0.4 dB < ±1.0 dB < ±0.2 dB < ±0.6 dB (50 MHz - 2.5 GHz)
Center frequency leakage power measurement Residual center frequency leakage power	After Auto Level Set is executed for the WiBro downlink signal, relative to averaged subcarrier power. < -40 dB
Frequency error measurement Measurement range Measurement accuracy	< ±200 Hz After Auto Level Set is executed for the WiBro downlink signal, Averaged frequency error on 25 symbol. < ±(10 + Center Frequency × Frequency reference error + Residual FM) Hz

APPENDIX

This section describes the following supplemental information:

A.1 Technical Data

A.2 Error Message List

A.1 Technical Data

A.1.1 Measured Value Calculation Method

Constellation Error

Constellation Error RMS of Total Result is calculated by using the following equation that is modified from the defined equation for Constellation Error. The defined equation is described in "8.4.12.3 Transmitter constellation error and test method" of "IEEE P802.16-REVd/D5, May 2004":

$$Error_{rms} = \frac{\sum_{i=1}^{N_f} \sqrt{\sum_{j=1}^{L_p} \left[\sum_{k=1}^{864} \left\{ (I(i, j, k) - I_0(i, j, k))^2 + (Q(i, j, k) - Q_0(i, j, k))^2 \right\} \right]}}{N_f \cdot 864 \cdot L_p \cdot P_o}$$

N_f : Number of measured frame

L_p : Number of measured Symbol

P_o : Average Power of constellation

I,Q measured signal

I_0, Q_0 : Ideal signal

The average power P_o is found by averaging the powers of all subcarriers in the measurement symbol range.

The RMS value of Constellation Error Time is calculated for each symbol by using the defined equation for Constellation Error.

The RMS value of Constellation Error Spectrum is calculated for each subcarrier by using the defined equation for Constellation Error.

The Constellation Error value to be plotted is calculated for each symbol and each subcarrier by using the defined equation for Constellation Error.

A.1.1 Measured Value Calculation Method

Magnitude Error

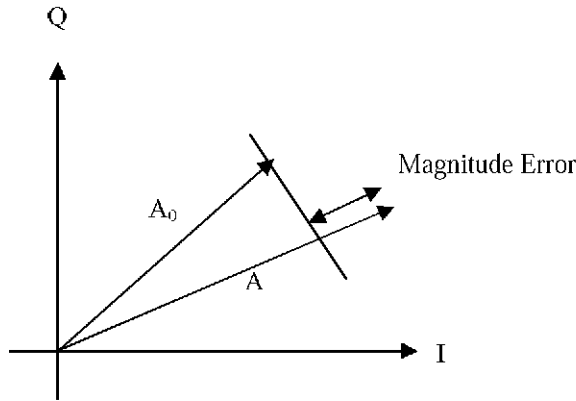

Assuming subcarrier number k , symbol number j , frame number i , ideal constellation $(I_0(i, j, k), Q_0(i, j, k))$, and measurement symbol $(I(i, j, k), Q(i, j, k))$, the amplitude of the ideal constellation A_0 and the amplitude of the measurement symbol A are defined as follows:

$$A_0(i, j, k) = \sqrt{(I_0(i, j, k))^2 + (Q_0(i, j, k))^2}$$

$$A(i, j, k) = \sqrt{(I(i, j, k))^2 + (Q(i, j, k))^2}$$

Calculate the Magnitude Error RMS of the Total Result with the following formula.

$$MagError_{RMS} = \frac{\sum_{i=1}^{N_f} \sqrt{\frac{\sum_{j=1}^{L_p} \left[\sum_{k=1}^{N_s} \left\{ \frac{(A(i, j, k) - A_0(i, j, k))^2}{(A_0(i, j, k))^2} \right\} \right]}{N_s \times L_p}}}{N_f}$$

N_s is the number of subcarriers, L_p the length of packet (number of symbols) and N_f the number of frames. The RMS value of Magnitude Error Time is calculated for each symbol, using the formula for defining Magnitude Error. The RMS value of Magnitude Error Spectrum is calculated for each subcarrier, using the formula for defining Magnitude Error. The Magnitude Error values to be plotted are calculated for each symbol and subcarrier, using the formula for defining Magnitude Error.

Phase Error

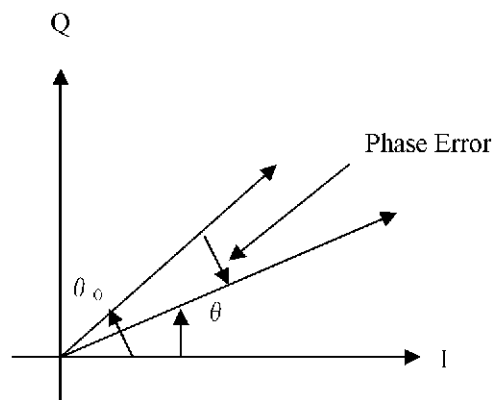

The phase of the ideal constellation θ_0 and the phase of the measurement symbol θ are defined as follows:

$$\theta_0(i, j, k) = \arctan \left[\frac{Q_0(i, j, k)}{I_0(i, j, k)} \right]$$

$$\theta(i, j, k) = \arctan \left[\frac{Q(i, j, k)}{I(i, j, k)} \right]$$

Calculate the Phase Error RMS of the Total Result with the following formula.

$$PhaseError_{RMS} = \frac{\sum_{i=1}^{N_f} \sqrt{\frac{\sum_{j=1}^{L_p} \left[\sum_{k=1}^{N_s} \{(\theta(i, j, k) - \theta_0(i, j, k))^2\} \right]}{N_s \times L_p}}}{N_f}$$

The AVG value of Phase Error Time is calculated for each symbol, using the average value of Phase Error. For the AVG value of Phase Error Spectrum, the average value of Phase Error is calculated for each subcarrier. For Phase Error values to be plotted, Phase Error is calculated for each symbol and subcarrier.

Magnitude Flatness

For Magnitude Flatness, the ratio of the amplitude of the measurement symbol to the amplitude of the ideal constellation is calculated. The difference from Magnitude Error is shown in the following formula.

$$MagError(i, j, k) = \frac{A(i, j, k) - A_0(i, j, k)}{A_0(i, j, k)}$$

$$MagFlat(i, j, k) = \frac{A(i, j, k)}{A_0(i, j, k)}$$

A.1.1 Measured Value Calculation Method

For the AVG value of Magnitude Flatness Time, the average value of Magnitude Flatness is calculated for each symbol. For the AVG value of Magnitude Flatness Spectrum, the average value of Magnitude Flatness is calculated for each subcarrier. For Magnitude Flatness values to be plotted, Magnitude Flatness is calculated for each symbol and subcarrier.

Center Frequency Error

Center Frequency Error is estimated by calculating the correlation between the OFDM symbol guard interval and the original data, and finding the phase shift that occurred during the FFT interval.

The following figure shows the OFDM symbol structure and data range that is used to calculate the correlation:

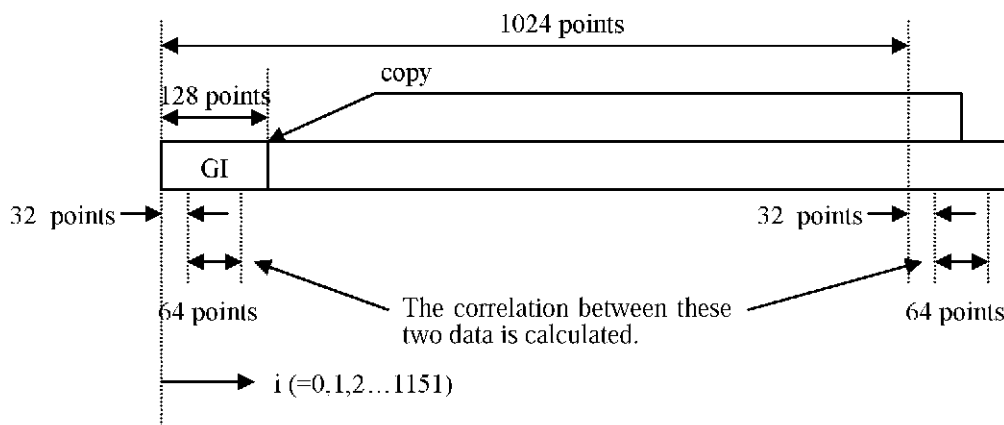

The equation that is used to calculate Center Frequency Error is as follows:

$s(i)$ is the time-series data from the OFDM symbol.

$$error = \frac{1}{64} \sum_{i=0}^{63} \left\{ \arctan \left[\frac{\text{Im}(s(i+1024) \times s^*(i))}{\text{Re}(s(i+1024) \times s^*(i))} \right] \right\} \times \frac{10\text{MHz}}{2\pi \times 1024}$$

Center Frequency Error is calculated for each OFDM symbol.

The frequency error that is displayed in Total Result is acquired by averaging the frequency error of each OFDM symbol in the measurement symbol range.

If multiple frames are measured, the center frequency error is acquired by averaging the frequency error of each frame.

Power

Power is calculated from the subcarrier power that is obtained by demodulating (FFT) each symbol. For the AVG value of Power Time, the average power of all subcarriers is calculated for each symbol. For the AVG value of Power Spectrum, the average power of all symbols is calculated for each subcarrier.

The Power of the Total Result is the average value of total power obtained by aggregating the AVG values of Power Spectrum. The value indicated with the unit of [W/MHz] is the value obtained by dividing the average value of total power with the frequency band width [MHz] of the OFDM signal. The bandwidth here is not OBW, but the value obtained from the difference in frequencies of the two subcarriers most apart upwards and downwards from the center frequency.

For WiBro, the frequency bandwidth is 8.30 MHz (=9.76 kHz × 850 subcarriers).

Spectral Flatness

Spectral Flatness is calculated based on the definition described in “8.4.12.2 Transmitter spectral flatness” of “IEEE P802.16-REVd/D5, May 2004”.

Data that is used to calculate Spectral Flatness is Power Spectrum of the second preamble.

If multiple frames are measured, Spectral Flatness is acquired by averaging the power spectrum of each frame.

“Avg” displays the differences between the average power in the -432 to +432 subcarrier range (as the reference: 0 dB) and the average power in the following four subcarrier ranges; -432 to -216, -216 to -1, +1 to +216, and +216 to +432.

When the measurement that is compliant with the above standard is performed, refer to this Avg value.

“MAX” and “MIN” display the differences between the reference power and the maximum and minimum subcarrier powers in the following four subcarrier ranges; -432 to -216, -216 to -1, +1 to +216, and +216 to +432.

Center Frequency Leakage

Center Frequency Leakage is calculated based on the definition that is described in “17.3.9.6.1 Transmitter center frequency leakage” of “IEEE Std 802.11a-1999”.

Data that is used to calculate Center Frequency Leakage is Power Spectrum of the second preamble.

If multiple frames are measured, Center Frequency Leakage is acquired by averaging the power spectrum of each frame.

Center Frequency Leakage indicates the difference between the reference power and the power of subcarrier number 0.

The total power of subcarrier numbers -432 to +432 and the average power of subcarrier numbers -432 to +432 are defined as the reference powers. Two results of Center Frequency Leakage, which are acquired by using these two reference powers, are displayed in Total Result.

A.1.2 Estimation of the Subcarrier Modulation Format

The subcarrier modulation format is estimated by finding the ideal symbols, at which the constellation error between the ideal symbol point and the symbol is at a minimum, for QPSK, 16QAM, and 64QAM and then comparing the ideal symbols to find the smallest constellation error.

IMPORTANT: *If Constellation Error deteriorates sufficiently, the modulation format may be estimated incorrectly and incorrect measurement values are displayed.*

A.1.3 Frequency Characteristics Correction Function

CH Estimation (Preamble)

This function estimates the frequency characteristics (gain and phase) by using the preamble of a standard signal. Because the preamble signal is predetermined by the standard, the correction values of the phase and amplitude can be determined for each subcarrier in the preamble so that the amplitude error and phase error are minimized.

After data is corrected by using this correction value, Constellation Error is calculated.

A.1.3 Frequency Characteristics Correction Function

CH Estimation (Pilot)

The correction values are calculated by using the pilot subcarrier so that magnitude error and phase error are minimized. Frequency characteristics where no pilot subcarrier exists are interpolated by using linear interpolation.

Equalizer

Equalizer is a function which corrects frequency characteristics by using data that is complementary to the error which is displayed in Constellation Error Spectrum.

The correction data is created when the **[Make]** button of Equalizer Data is pressed.

The difference between Equalizer and CH Estimation is that Equalizer creates correction data only when the **[Make]** button of Equalizer is pressed and the data is held until the **[Make]** button is re-pressed whereas CH Estimation automatically estimates frequency characteristics every time a frame is analyzed.

Equalizer is suitable when Constellation Errors, which are measured before and after the amplifier or filter is inserted, are compared.

Use Equalizer according to the following procedures: (Refer to measurement examples in Chapter 4.)

1. Connect the signal source such as SG directly to the measurement instrument and measure Constellation Error.
Select CH Estimation(Preamble) from the **[Correction Type]** menu in the **[Mod Analysis(1) Setup]** dialog box.



NOTE: *Equalizer does not correct a signal source distortion, IQ signal unbalance, and quadrature modulator error.
If the signal includes Constellation Error deterioration because of these causes, Constellation Error cannot be improved even by using Equalizer.*

2. Press the **[Make]** button of **[Equalizer Data]** in the **[Mod Analysis(1) Setup]** dialog box. The correction data is calculated.
3. Select Equalizer from the menu of **[Correction Type]** in the **[Mod Analysis(1) Setup]** dialog box.
4. Measure Constellation Error again.
Constellation Error that was corrected by Equalizer is displayed.
5. Connect the DUT to the signal source and measurement instrument, and measure Constellation Error.
The Constellation Error that was deteriorated by the DUT is displayed.

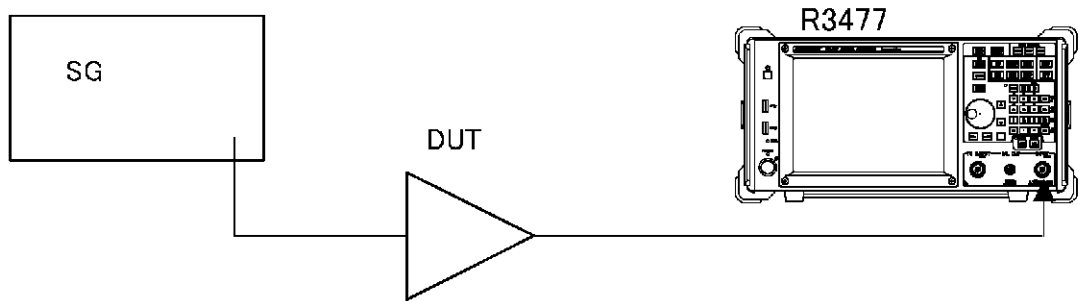

Some measurement results can be improved by using CH Estimation(Preamble), CH Estimation(Pilot), or Equalizer in which the frequency characteristics are corrected.

The following table shows whether each measurement result can be improved.

Table A-1 Frequency Characteristics Correction by using Equalizer

Measurement result	○ : Can be improved × : Cannot be improved
Total Result -> Cnst Error	○
Total Result -> Mag Error	○
Total Result -> Phase Error	○
Total Result -> Tau	×
Total Result -> Freq Error	×
Total Result -> Power	×
Total Result -> Flatness	×
Total Result -> Leak-Power	×
Total Result -> Lk-SubCarAvg	×
Constellation Error Time	○
Constellation Error Spectrum	○
Mag Error Time	○
Mag Error Spectrum	○
Phase Error Time	○
Phase Error Spectrum	○
Mag Flatness Time	○
Mag Flatness Spectrum	○
Power Time	×
Power Spectrum	×
Constellation	○
Center Freq Error Time	×
Demodulated Data	○
Group Delay Spectrum	×
Spectrogram	×

A.1.4 Pilot Synchronization Function

A.1.4 Pilot Synchronization Function

Pilot Track (Amplitude)

The amplitude is estimated, corrected, and analyzed for each symbol by using the pilot subcarrier. This function is effective when the amplitude fluctuates over time.

Pilot Track (Phase)

This function performs the symbol synchronization, initial phase estimation, and analysis for each symbol by using the pilot subcarrier. This function is effective when the carrier frequency fluctuates or the FFT sampling frequency fluctuates.

(If Pilot Track is set to OFF, the amplitude, symbol synchronization, and initial phase for each symbol are not estimated after they were estimated by using the preamble.)

A.2 Error Message List

This section describes the error messages displayed on this instrument.

The following information is included.

- Error number
- Displayed message
- Cause of generation and cancellation method

Table A-2 shows the error messages that are unique to this option.

For more information on other error messages, refer to Section 9.8, "Error Message List" of the R3477 Series User's Guide.

Table A-2 Error Message List (1 of 2)

Error number	Displayed message	Description
-2250	Template table contains no data.	The function cannot be performed because no data exists in the template table.
-2251	Not available. T-Domain Power is ON.	Cannot be executed in the T-Domain Power measurement mode.
-2252	Not available. ON/OFF Ratio is ON.	Cannot be executed in the ON/OFF Ratio measurement mode.
-3210	Input Level is out of range. Check the Ref. Level.	The input signal level is out of the permitted range. Check the reference level or input signal level.
-3211	Auto Level Set cannot be succeed. Signal level is not stable.	Auto Level Set is not complete. Check to see if the input signal level is not constant or if the attenuator is set to manual.
-3220	Cannot find out signal. Input level may be too low.	No frame is detected in the A/D data.
-3222	Cannot find Preamble. Standard may be mismatched.	No preamble is detected at the beginning of a frame.
-3226	Not available while A/D capturing.	The operation cannot be accepted during A/D capture.
-3227	Not available while analyzing.	The operation cannot be accepted during a measurement (analysis).
-3230	Analysis has stopped. Equalizer data is not calculated.	The analysis is executed by using an Equalizer ON setting, even though no Equalizer data exists. Execute the analysis after calculating the Equalizer data.
-3231	Analysis has stopped. Press "Make" button again.	The analysis is executed by using invalid Equalizer data and an Equalizer ON setting. Execute the analysis after re-calculating the Equalizer data.
-3232	Cannot calculate equalizer data.	The Equalizer data cannot be calculated. Check whether the OFDM analysis has been completed correctly.

A.2 Error Message List

Table A-2 Error Message List (2 of 2)

Error number	Displayed message	Description
-3233	Cannot find Ramp Down. Frame length may be too long.	The falling edge of the frame cannot be detected. Check whether the whole frame is in the A/D Capture Length range.

ALPHABETICAL INDEX

[Symbol]		
√Nyquist Filter On/Off	5-6, 5-7, 5-12, 5-16, 5-18	
√Nyquist Filter Setup	5-7, 5-16, 5-18	
[All]	5-26, 5-27	
[Apply]	5-26, 5-27	
[Avg]	5-26, 5-27	
[Band Width]	5-16	
[Baseband Filter]	5-23	
[Carrier Band Width]	5-16	
[Cell ID]	5-23	
[Center Freq Error]	5-26	
[Center Freq Error Time]	5-24	
[Channel Space]	5-16	
[Constellation]	5-24	
[Constellation Error Spectrum]	5-25	
[Constellation Error Threshold]	5-22	
[Constellation Error Time]	5-24	
[Constellation Error Trigger]	5-22	
[Continuous Signal]	5-20	
[Correction Type]	5-21	
[Demodulated Data]	5-26	
[DL PermBase]	5-23	
[Equalizer Data]	5-21	
[Frame Length]	5-23	
[Group Delay Spectrum]	5-24	
[Integral BW Abs]	5-12	
[Integral BW Rel]	5-13	
[Judge]	5-13	
[Lim Abs Start]	5-13	
[Lim Abs Stop]	5-13	
[Lim Rel Start]	5-13	
[Lim Rel Stop]	5-13	
[Limit]	5-16	
[Mag Error Spectrum]	5-25	
[Mag Error Time]	5-24	
[Mag Flatness Spectrum]	5-25	
[Mag Flatness Time]	5-24	
[Meas Condition]	5-22	
[Meas Frame Length]	5-22	
[Meas Min Symbol Length]	5-22	
[Meas Symbol Length]	5-22	
[Meas Window Setup]	5-21	
[No Display]	5-24	
[Number of PUSC Symbol]	5-23	
[Phase Error Spectrum]	5-25	
[Phase Error Time]	5-24	
[Pilot Track(Amplitude)]	5-21	
[Pilot Track(Phase)]	5-22	
[Power Spectrum]	5-25	
[Power Time]	5-24	
[PRBS_ID]	5-23	
[RMS]	5-26, 5-27	
[Segment Number]	5-23	
[Set to Default]	5-23	
[Specified Subcarrier]	5-26, 5-27	
[Specified Symbol]	5-27	
[Start]	5-12	
[Stop]	5-12	
[Subchannel Type]	5-23	
[Symbol Timing]	5-21	
[τ Offset]	5-22	
[τ Offset Setup]	5-22	
[Template]	5-23	
[Threshold Level]	5-21	
[Threshold Setup]	5-20	
[Total Result]	5-25	
[Window Start]	5-21	
[Window Width]	5-21	
[A]		
Abs Meas 1/2	5-7, 5-17	
Abs Meas 2/2	5-7, 5-18	
ACLR	5-5, 5-7, 5-16	
ACLR Off	5-7, 5-17	
Auto Level Set	5-6, 5-7, 5-8, 5-9, 5-10, 5-11, 5-12, 5-14, 5-16, 5-17, 5-20, 5-29, 5-31, 5-32	
Average Mode Cont/Rep	5-6, 5-7, 5-9, 5-10, 5-11, 5-13, 5-17, 5-19, 5-30, 5-31	
Average Times On/Off	5-6, 5-7, 5-9, 5-10, 5-11, 5-13, 5-17, 5-19, 5-30, 5-31	
[B]		
Built-in Flash Memory	2-3	
[C]		
Carrier Band Width	5-6, 5-12	

Alphabetical Index

	5-9, 5-11,	
	5-14, 5-15,	
	5-17, 5-19,	
	5-30, 5-31	
SETUP	3-1	
Shift X	5-9, 5-29	
Shift Y	5-9, 5-29	
Show Result	5-6, 5-15	
Signal	5-8, 5-23	
Single Display	5-8, 5-27	
Single Meas	5-8	
Sort	5-6, 5-7,	
	5-9, 5-13,	
	5-16, 5-29	
SPECIFICATIONS	8-1	
SPECTRUM EMISSION MASK	5-12	
Spectrum Emission Mask	5-5, 5-6,	
	5-12	
Spectrum Emission Mask Off	5-6, 5-14	
Spectrum Trace	5-8, 5-27	
SPURIOUS EMISSIONS	5-14	
Spurious Emissions	5-5, 5-6,	
	5-14	
Spurious Emissions Off	5-6, 5-15	
Status Register	6-35	
Subsystem-CALCulate	6-31	
Subsystem-CONFigure	6-4, 6-21	
Subsystem-DISPlay	6-9, 6-30	
Subsystem-INITiate	6-8, 6-29	
Subsystem-INPut	6-4, 6-12	
Subsystem-MEASure/READ/FETCH ...	6-7, 6-22	
Subsystem-MMEMory	6-11, 6-30	
Subsystem-SENSE	6-5, 6-13	
Subsystem-STATus	6-34	
Subsystem-SYSTEM	6-11, 6-34	
Subsystem-TRIGger	6-9, 6-29	
Switching Communication Systems	5-4	
Symbol Rate	5-6, 5-7,	
	5-12, 5-16,	
	5-19	

[T]

Table No. 1/2/3	5-6, 5-14,	
	5-15	
T-Domain Power	5-5, 5-9,	
	5-29	
T-Domain Power Off	5-9, 5-30	
Technical Data	A-1	
Template	5-9, 5-29	
Template Couple to Power On/Off	5-9, 5-30	
Template Edit	5-9, 5-29	
Template Limit	5-9, 5-30	
Template On/Off	5-9, 5-29	

Template Up/Low	5-9, 5-29
Test Data Record Sheets	7-3
Test Procedures	7-2
Test Signal Specifications	7-1
Time Trace	5-8, 5-26
To Avoid Disrupting the Software	
Environment	2-4
Trace Write On/Off	5-9, 5-32
Trademarks	1-3
Trigger	5-8, 5-28
Trigger Delay	5-8, 5-28
Trigger Slope +/-	5-8, 5-28
Trigger Source	5-8, 5-28

[U]

Upper Limit	5-6, 5-9,
	5-10, 5-11,
	5-30

[W]

WiBro 16e Modulation Analysis	
Performance	8-1
Window Format	5-8, 5-23
Window On/Off	5-6, 5-9,
	5-10, 5-29
Window Position	5-6, 5-9,
	5-10, 5-29
Window Setup	5-6, 5-9,
	5-10, 5-29,
	5-31
Window Width	5-6, 5-9,
	5-10, 5-29

[X]

X Scale Left	5-8, 5-27
X Scale Max	5-9, 5-32
X Scale Right	5-8, 5-27

[Y]

Y Scale Lower	5-8, 5-28
Y Scale Upper	5-8, 5-28

IMPORTANT INFORMATION FOR ADVANTEST SOFTWARE

PLEASE READ CAREFULLY: This is an important notice for the software defined herein. Computer programs including any additions, modifications and updates thereof, operation manuals, and related materials provided by Advantest (hereafter referred to as "SOFTWARE"), included in or used with hardware produced by Advantest (hereafter referred to as "PRODUCTS").

SOFTWARE License

All rights in and to the SOFTWARE (including, but not limited to, copyright) shall be and remain vested in Advantest. Advantest hereby grants you a license to use the SOFTWARE only on or with Advantest PRODUCTS.

Restrictions

- (1) You may not use the SOFTWARE for any purpose other than for the use of the PRODUCTS.
- (2) You may not copy, modify, or change, all or any part of, the SOFTWARE without permission from Advantest.
- (3) You may not reverse engineer, de-compile, or disassemble, all or any part of, the SOFTWARE.

Liability

Advantest shall have no liability (1) for any PRODUCT failures, which may arise out of any misuse (misuse is deemed to be use of the SOFTWARE for purposes other than its intended use) of the SOFTWARE. (2) For any dispute between you and any third party for any reason whatsoever including, but not limited to, infringement of intellectual property rights.

LIMITED WARRANTY

1. Unless otherwise specifically agreed by Seller and Purchaser in writing, Advantest will warrant to the Purchaser that during the Warranty Period this Product (other than consumables included in the Product) will be free from defects in material and workmanship and shall conform to the specifications set forth in this Operation Manual.
2. The warranty period for the Product (the "Warranty Period") will be a period of one year commencing on the delivery date of the Product.
3. If the Product is found to be defective during the Warranty Period, Advantest will, at its option and in its sole and absolute discretion, either (a) repair the defective Product or part or component thereof or (b) replace the defective Product or part or component thereof, in either case at Advantest's sole cost and expense.
4. This limited warranty will not apply to defects or damage to the Product or any part or component thereof resulting from any of the following:
 - (a) any modifications, maintenance or repairs other than modifications, maintenance or repairs (i) performed by Advantest or (ii) specifically recommended or authorized by Advantest and performed in accordance with Advantest's instructions;
 - (b) any improper or inadequate handling, carriage or storage of the Product by the Purchaser or any third party (other than Advantest or its agents);
 - (c) use of the Product under operating conditions or environments different than those specified in the Operation Manual or recommended by Advantest, including, without limitation, (i) instances where the Product has been subjected to physical stress or electrical voltage exceeding the permissible range and (ii) instances where the corrosion of electrical circuits or other deterioration was accelerated by exposure to corrosive gases or dusty environments;
 - (d) use of the Product in connection with software, interfaces, products or parts other than software, interfaces, products or parts supplied or recommended by Advantest;
 - (e) incorporation in the Product of any parts or components (i) provided by Purchaser or (ii) provided by a third party at the request or direction of Purchaser or due to specifications or designs supplied by Purchaser (including, without limitation, any degradation in performance of such parts or components);
 - (f) Advantest's incorporation or use of any specifications or designs supplied by Purchaser;
 - (g) the occurrence of an event of force majeure, including, without limitation, fire, explosion, geological change, storm, flood, earthquake, tidal wave, lightning or act of war; or
 - (h) any negligent act or omission of the Purchaser or any third party other than Advantest.
5. **EXCEPT TO THE EXTENT EXPRESSLY PROVIDED HEREIN, ADVANTEST HEREBY EXPRESSLY DISCLAIMS, AND THE PURCHASER HEREBY WAIVES, ALL WARRANTIES, WHETHER EXPRESS OR IMPLIED, STATUTORY OR OTHERWISE, INCLUDING, WITHOUT LIMITATION, (A) ANY WARRANTY OF MERCHANTABILITY OR FITNESS FOR A PARTICULAR PURPOSE AND (B) ANY WARRANTY OR REPRESENTATION AS TO THE VALIDITY, SCOPE, EFFECTIVENESS OR USEFULNESS OF ANY TECHNOLOGY OR ANY INVENTION.**
6. **THE REMEDY SET FORTH HEREIN SHALL BE THE SOLE AND EXCLUSIVE REMEDY OF THE PURCHASER FOR BREACH OF WARRANTY WITH RESPECT TO THE PRODUCT.**
7. **ADVANTEST WILL NOT HAVE ANY LIABILITY TO THE PURCHASER FOR ANY INDIRECT, INCIDENTAL, SPECIAL, CONSEQUENTIAL OR PUNITIVE DAMAGES, INCLUDING, WITHOUT LIMITATION, LOSS OF ANTICIPATED PROFITS OR REVENUES, IN ANY AND ALL CIRCUMSTANCES, EVEN IF ADVANTEST HAS BEEN ADVISED OF THE POSSIBILITY OF SUCH DAMAGES AND WHETHER ARISING OUT OF BREACH OF CONTRACT, WARRANTY, TORT (INCLUDING, WITHOUT LIMITATION, NEGLIGENCE), STRICT LIABILITY, INDEMNITY, CONTRIBUTION OR OTHERWISE. TORT (INCLUDING, WITHOUT LIMITATION, NEGLIGENCE), STRICT LIABILITY, INDEMNITY, CONTRIBUTION OR OTHERWISE.**
8. **OTHER THAN THE REMEDY FOR THE BREACH OF WARRANTY SET FORTH HEREIN, ADVANTEST SHALL NOT BE LIABLE FOR, AND HEREBY DISCLAIMS TO THE FULLEST EXTENT PERMITTED BY LAW ANY LIABILITY FOR, DAMAGES FOR PRODUCT FAILURE OR DEFECT, WHETHER ARISING OUT OF BREACH OF CONTRACT, TORT (INCLUDING, WITHOUT LIMITATION, NEGLIGENCE), STRICT LIABILITY, INDEMNITY, CONTRIBUTION OR OTHERWISE.**

CUSTOMER SERVICE DESCRIPTION

In order to maintain safe and trouble-free operation of the Product and to prevent the incurrence of unnecessary costs and expenses, Advantest recommends a regular preventive maintenance program under its maintenance agreement.

Advantest's maintenance agreement provides the Purchaser on-site and off-site maintenance, parts, maintenance machinery, regular inspections, and telephone support and will last a maximum of ten years from the date the delivery of the Product. For specific details of the services provided under the maintenance agreement, please contact the nearest Advantest office listed at the end of this Operation Manual or Advantest's sales representatives.

Some of the components and parts of this Product have a limited operating life (such as, electrical and mechanical parts, fan motors, unit power supply, etc.). Accordingly, these components and parts will have to be replaced on a periodic basis. If the operating life of a component or part has expired and such component or part has not been replaced, there is a possibility that the Product will not perform properly. Additionally, if the operating life of a component or part has expired and continued use of such component or part damages the Product, the Product may not be repairable. Please contact the nearest Advantest office listed at the end of this Operation Manual or Advantest's sales representatives to determine the operating life of a specific component or part, as the operating life may vary depending on various factors such as operating condition and usage environment.

SALES & SUPPORT OFFICES

Advantest Korea Co., Ltd.

22BF, Kyobo KangNam Tower,
1303-22, Seocho-Dong, Seocho-Ku, Seoul #137-070, Korea
Phone: +82-2-532-7071
Fax: +82-2-532-7132

Advantest (Suzhou) Co., Ltd.

Shanghai Branch Office:
Bldg. 6D, NO.1188 Gumei Road, Shanghai, China 201102 P.R.C.
Phone: +86-21-6485-2725
Fax: +86-21-6485-2726

Shanghai Branch Office:
406/F, Ying Building, Quantum Plaza, No. 23 Zhi Chun Road,
Hai Dian District, Beijing,
China 100083
Phone: +86-10-8235-3377
Fax: +86-10-8235-6717

Advantest (Singapore) Pte. Ltd.

438A Alexandra Road, #08-03/06
Alexandra Technopark Singapore 119967
Phone: +65-6274-3100
Fax: +65-6274-4055

Advantest America, Inc.

3201 Scott Boulevard, Suite, Santa Clara, CA 95054, U.S.A
Phone: +1-408-988-7700
Fax: +1-408-987-0691

ROHDE & SCHWARZ Europe GmbH

Mühldorfstraße 15 D-81671 München, Germany
(P.O.B. 80 14 60 D-81614 München, Germany)
Phone: +49-89-4129-13711
Fax: +49-89-4129-13723

ADVANTEST[®]

<http://www.advantest.co.jp>